

**M850-LTHN
MultiPower
Installation and Operation Manual**
(Revision 1.0.0)

July 2014



Table of Contents

Chapter 1: Meter Overview and Specifications

1.1	Hardware Overview	4
1.1.1	Voltage and Current Inputs	5
1.1.2	Model Number plus Option Codes	6
1.1.3	Measured Values	7
1.2	Specifications	7
1.3	Compliance	10

Chapter 2: Mechanical Installation

2.1	Introduction / Cut-Out Details	11
2.2	Panel Mounting Procedure	11
2.3	Terminal Block Notes	12

Chapter 3: Electrical Installation

3.1	Considerations When Installing Meters	13
3.2	Voltage and Power Supply Connections	14
3.3	Terminations to Meter	15
3.4	Electrical Connection Diagrams	15

Chapter 4: Communications

4.1	Overview, Optional USB to RS485 adapter, Pulse output card	16
4.2	Using the Communications Software	17
4.2.1	Software Installation using RS485 to USB	17
4.3	Measurement Logging with MultiView	19
4.4	Network Description	21
4.5	Measurement Registers (3X and 4X)	21
4.5.1	3X Registers	23
4.5.2	4X Registers	29
4.6	M850-LTHN-RS Communications and Programming Overview	30

Chapter 5: Using the M850-LTHN Meter

5.1	Introduction	32
5.1.1	Meter Face Elements	32
5.1.2	Display Screens	33
5.2	Settings Menu including abbreviations as seen on screen	34
5.2.1	Supply (SUPP) Sub-menu	35
5.2.2	Communications (COMMS RS485) Sub-menu	37
5.2.3	Demand (DT) Sub-Menu	38
5.2.4	Energy (ENGY) Sub-Menu	39
5.2.5	Relay (RLAY) Sub-Menu	40
5.2.6	Code (CODE) Sub-Menu	41
5.2.7	EEPROM (STOR) Sub-Menu	41
5.2.8	End (END) Sub-Menu	41

Chapter 6: Configuring the M850-LTHN Using the Front Panel		
6.1	System Type Programming	42
6.2	Configure CT Ratio Settings	43
6.2.1	CT Ratio Programming	43
6.3	Configure VT Ratio Settings	44
6.3.1	VT Ratio Programming	45
6.4	Configure Max Demand Time Setting	46
6.4.1	Max Demand Time Setting	47
Appendix A: Modbus Registers		
A.1	3X and 4X Registers	48
A.2	Register Addresses and Modes	49
Appendix B: M850-LTHN Quick Start Guide		50
Appendix C: Programming Screens		52
C.1	Main menu screen	52
C.2	Supply programming screen	52
C.3	Communications programming screen	52
C.4	Demand programming screen	53
C.5	Energy programming screen	53
C.6	Relay programming screen	54
C.7	Code programming screen	54
C.8	Store programming screen	55
C.9	End programming screen	55
Appendix D: Ethernet Card Installation and Set-Up		56
	(when used with M850-THD-ET)	

Chapter 1: Meter Overview and Specifications

1.1

Hardware Overview



*M850-LTHN
MultiPower
AC Meter*

The M850-LTHN MultiPower is a complete 3 phase digital, universal metering system in a standard 96 x 96 mm DIN case. It is a cost-effective replacement for traditional panel meters. This multi-function power meter is suitable for low, medium and high voltage control panels, gensets, load banks, building management systems and power management systems.

The M850-LTHN can be used on single phase or a single phase 3-wire system; 3-phase 3-wire balanced or unbalanced systems, as well as 3-phase 4-wire balanced or unbalanced systems.

With optional extra RS485 (MODBUS protocol) and pulsed output options can be purchased with the M850-LTHN MultiPower meter. The RS485 and Pulse output will be built in the unit to enable remote reading of up to 32 MultiPower units on a single 2-wire bus using MODBUS protocol. The RS485 option is compatible with PC, PLC, RTU, data loggers and SCADA programs.

The M850-LTHN MultiPower:

- Complete single phase and 3-phase digital universal metering system. Covers a majority of applications without any modifications
- Measures a standard range of 19 different parameters. Easy to use and easy to program from the front panel.
- CT ratios, PT ratios and calibration data are stored in non-volatile EEPROM memory. In power-loss conditions, the data is retained.
- Four, easy-to-access, front control buttons are used for scrolling up or down through the parameters.
- Unique LCD FSTN display allows the user to select back lighting color options of white, green or blue.
- RS485 option and a pulsed output option can be ordered with the M850-LTHN MultiPower unit, this will then make the part number M850-LTHN-RS-PO.
- The RS485 (MODBUS protocol) unit enables remote reading of up to 32 MultiPower meters on a single, 2-wire bus.
- Pulsed output option is via a relay and can be assigned to W.h. and VAR.h.
- Free software for monitoring and logging available on request or visit <http://www.hobut.co.uk/images/HOBUT-MViewV02.zip>

The four front control buttons are used for scrolling up or down through the parameters being measured and displayed. These buttons also allow programming of different current and voltage transformer ratios, demand times, baud rates, etc.

The M850-LTHN MultiPower is housed in a 96 mm x 96 mm DIN style case. The case is constructed of black polycarbonate and is compliant with UL 94VO. The front panel of the case has an enclosure code of IP52.

**1.1.1
Voltage and Current Inputs**

Voltage inputs allow measurement from 28V to 330V line-to-neutral and 48V to 600V line-to-line. This insures proper meter safety when wiring directly to high voltage systems. The M850-LTHN has an input overload rating of 800V, AC continuous. The aux power required is 100 to 440V AC / 100 to 420V DC power systems. A separate unit have an auxiliary voltage supply of 19 to 69V DC is available as optional extra. The M850-LTHN MultiPower operates at 45-65Hz standard; another unit is available for 400Hz applications.

General Specifications:

Accuracy	Volts/Amps:	0.5% of reading ± 2 digits
	Frequency:	0.1Hz ± 1 digit
	Reactive Power:	1% of reading ± 2 digits
	Apparent Power:	1% of reading ± 2 digits
	Power Factor:	1% of reading ± 2 digits
	Energy:	IEC 1036 Class I
Rated Un	28V to 330V (L-N) and 48V to 570V (L-L)	
Un Overload	800V continuous	
Burden	0.5VA per phase	
Rated In	0.5 to 6A (via CT)	
Input Overload	10 x In for 1 second	
Input Burden	0.5VA per phase	
Frequency	45 – 65 Hz; 400Hz available as separate unit	
Auxiliary Voltage	100 to 440V,AC / 100 to 420V,DC (19 to 69V,DC optional)	

The auxiliary supply can be connected in parallel with the measuring input voltage, but this restricts the measuring range of the input voltage to ± 15% of nominal. If the auxiliary is separate the measuring range of the voltage input is 10-120%.

Current Transformers:

The M850-LTHN MultiPower can be supplied as 5 Amps, 1 Amp or 0.333mV unit. The current circuit is designed for connection to the secondary of external CT. These transformers should conform to at least accuracy class 1 or preferably ANSI C57.13 or equal.

The secondary of these external transformers must have the same nominal current input as that specified on the data label on the M850-LTHN. For example, if the M850-LTHN has a current ratio specified as 500/5A, then the CT could be changed to 800/5A (or any ratio with secondary 5A) and used once the current ratio has been programmed into the M850-LTHN.

But if the ratio change was 800/1A, the M850-LTHN would have to be returned to the factory to have the internal circuits changed to 1 Amp at a cost or purchase a new unit.



Warning: The secondary of a current transformer must never be allowed to be in an open circuit condition when the primary is energized. In the open circuit condition high voltage may be present. Each current transformer secondary should be short-circuited when not connected to the meter.

Voltage (Potential) Transformers:

Connection of voltages higher than the rated voltage that is specified on the M850-LTHN data label, is possible using external voltage (potential) transformers. These transformers must be at least Class 1 accuracy.

The secondary of these transformers must have the same nominal voltage as that programmed into the meter otherwise the reading will be incorrect.

1.1.2

Model Number for Additional M850 Units plus Option Codes

Part Number	Description
M850-LTHN	Standard MultiPower AC meter; Input: 25-300V (L-N) @ 5A,AC; 45-65Hz; Aux: 100-440V,AC/100-420V,DC. LCD Display.
M850-LTHN-1	Standard MultiPower AC meter; Input: 25-300V (L-N) @ 1A,AC; 45-65Hz; Aux: 100-440V,AC/100-420V,DC. LCD Display.
M850-LTHN-MV	Standard MultiPower AC meter with current clamp inputs of 333mV,AC, 45-65Hz; Aux: 100-440V,AC/100-420V,DC. LCD Display.
M850-LTHN-400	Standard MultiPower AC meter; ; Input: 25-300V (L-N) @ 5A,AC; 400Hz; Aux: 100-440V,AC/100-420V,DC. LCD Display.
M850-LTHN-DC	Standard MultiPower AC meter; Input: 25-300V (L-N) @ 5A,AC; 45-65Hz; Aux: 19-69V,DC LCD Display
M850-LTHN-RS-PO	Standard MultiPower AC meter; Input: 25-300V (L-N) @ 5A,AC; 45-65Hz; Aux: 100-440V,AC/100-420V,DC. LCD Display. Complete with RS485 and Pulse output
M850-LTHN-RS-PO-1	Standard MultiPower AC meter; Input: 25-300V (L-N) @ 1A,AC; 45-65Hz; Aux: 100-440V,AC/100-420V,DC. LCD Display. Complete with RS485 and Pulse output
M850-LTHN-RS-PO-MV	Standard MultiPower AC meter with current clamp inputs of 333mV,AC Aux: 100-440V,AC/100-420V,DC. LCD Display. complete with RS485 and Pulse output
M850-LTHN-RS-PO-400	Standard MultiPower AC meter; Input: 25-300V (L-N) @ 5A,AC; 400Hz; Aux: 100-440V,AC/100-420V,DC. LCD Display. Complete with RS485 and Pulse output
M850-LTHN-RS-PO-DC	Standard MultiPower AC meter; Input: 25-300V (L-N) @ 5A,AC; 45-65Hz; Aux: 19-69V,DC complete with RS485 and Pulse output
M850-THD-ET	Standard MultiPower AC meter with Total Harmonic Distortion with Ethernet connection
M850-BAC	Plug-in option for RS485 BACnet protocol (to work with M850-THD only)

1.1.3

Measured Values

Phase Power L-L (V)	Instantaneous Demand Amp
Phase to Neutral L-N (V)	Instantaneous Demand Apparent Power
Phase Current (I)	Maximum Demand Amps
Frequency (Hz)	Maximum Demand Active Power
Active Power (W)	Maximum Demand Apparent Power
Reactive Power (VA)	Maximum Active Power Demand
Active Energy (W.h.)	Maximum Reactive Power Demand
Reactive Energy (VAR.h)	THD Current
Power Factor (P.F.)	THD Voltage

1.2

Specifications

Input

Range:	28V to 330V (L-N); 48V to 570V (L-L)
Burden:	<0.5 VA per phase
In:	0.5A to 6A via current transformer
Frequency:	45 – 65Hz standard; 400Hz unit also available

Secondary of CT's must be connected to earth

Overload

UN:	800V (L-L) continuous
IN:	10 In for 1 second
	10 x In

Accuracy

Voltage (V):	0.5% ± 2 digits
Current (I):	0.5% ± 2 digits
Power (W, VAr, VA):	1.0% ± 2 digits
Power Factor (PF):	1% of range (reading) ± 2 digits
Frequency (Hz):	0.1 Hz ± 1 digit
Energy (kWh, VARh):	IEC 1036 Class 1

Auxiliary Voltage

Range:	100V to 440V,AC (45 to 65Hz) / 100V to 420V,DC
Burden:	<10VA

Display

Digits:	3 lines, 9999, +1 line 99999999, multicolour LCD Screen
Digit Size:	3 lines of 14.2mm, 7 segment
	1 line of 6mm, 7 segment (for kW.h or kVar.h)
Update Time:	1 second

Insulation

Installation Category:	III (480V,AC L-L)
Degree of Pollution:	2
Rated Impulse Withstand Voltage:	IEC 60947-1-V imp: 4kV
Meters Front:	Class II
Electrical Security:	IEC 61010-1

Environment

Working Temperature:	32°F to +140°F (0°C to +60°C) (Extended ranges available)
Storage Temperature:	-40°F to +185°F (-40°C to +85°C)
Relative Humidity:	0-95% non-condensing
Shock:	30G in 2 planes
Faceplate Rating:	IP52 Front Panel

Enclosure

Standard DIN case:	96 mm x 96 mm x 60 mm
Panel Mounting:	4 retaining clips
Cutout:	92.8 mm x 92.8 mm

Applied Standards

Immunity to:	
- Electrostatic discharges:	IEC 61000-4-2-Level III
- Radiated radio-Hz fields:	IEC 61000-4-3-Level III
- Electrical fast transient / bursts:	IEC 61000-4-4-Level III
- Impulse waves:	IEC 61000-4-5-Level III
- Conducted disturbances:	IEC 61000-4-6-Level III
- Voltage dips & short interruptions:	IEC 61000-4-11
Emissions to:	
- Conducted and radiated	CISPR11-Class A
Safety:	IEC 1010; BSEN 601010
UL:	File No. E337752

Options:

RS485 (MODBUS protocol)
Pulsed output (for W.h or VAR.h)
BACnet protocol on request with M850-THD

Communication Format

RS485 (MODBUS):	Port: through back plate Baud Rate: 38400, 19200, 9600, 4800, 2400 Parity: Odd, even, no parity Address: 1 to 247 Data Format: 8 bit Protocols: MODBUS (RTU, MODBUS), BACnet MS/TP
-----------------	--

Ethernet module:
When used with M850-THD

Supported Protocols:
Telnet Port 23
MODBUS TCP/IP Port 502
MODBUS TCP Port 4000
HTML Port 80

A cross-over CAT5 Ethernet cable should be used if the network card does not automatically swap lines to suit the cable's terminations.

Controller: Incorporates 10/100 Base-T

Factory Default Setting of module:

IP = 192.168.92.123

Subnet = 255.255.255.0

Gateway = 192.168.92.254

Mechanical Parameters

Dimensions:

Across front panel: 96mm high x 96mm wide

Depth: Front screen depth: 19mm

Meter body to edge of terminal block: 61mm

Meter body to edge of plug-in module: 82mm

Weight:

0.66 lbs.

Dimensions of the M850-LTHN-RS-PO

(shown in mm)

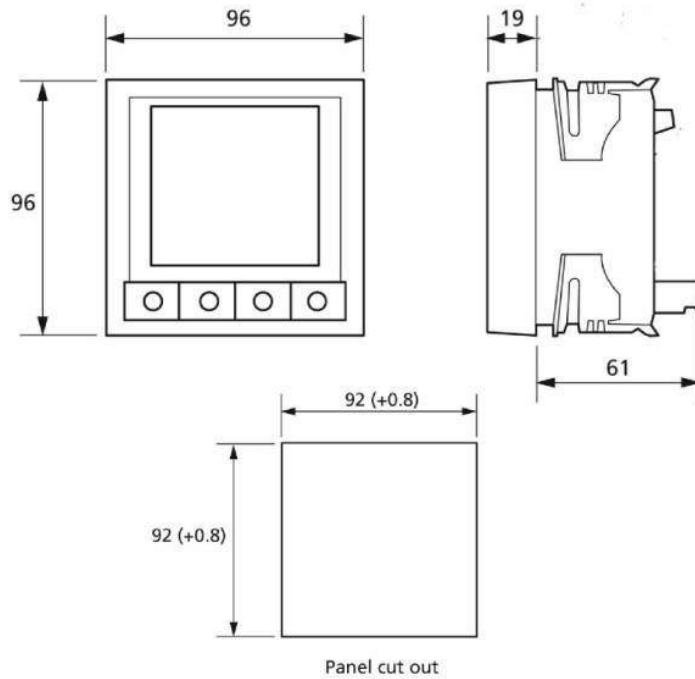

1.3

Compliance

Compliance Standard	Applicable to
ANSI C37.90A	Insulation Surge Withstand
BS4753	Insulation Protection, Class II
BS4889	General Construction
BSEN601010	Safety
BSEN60688	General Construction
CISPR11 Class A	Conducted and radiated emissions compatibility
DIN 57411	Insulation Protection, Class II
EN 55020 HF	Insulation Impulse Test
IEC 1010	Safety
IEC 255-4	Insulation Interference
IEC 348	Insulation Protection, Class II
IEC 359	General Construction
IEC 688	General Construction
IEC 801	Insulation Surge Withstand
IEC 1036 Class I	Energy Accuracy
IEC 61000-4-2-Level III	Electrostatic discharge immunity level
IEC 61000-4-3-Level III	Radiated radio-Hz field immunity level
IEC 61000-4-4-Level III	Electrical fast transient / burst immunity
IEC 61000-4-5-Level III	Impulse wave immunity level
IEC 61000-4-6-Level III	Conducted disturbances immunity level
IEC 61000-4-11	Voltage dips and short interruptions immunity level
VDE	Insulation Protection, Class II
(UL) E337752	UL file number
UL94 VO	Case / Enclosure

Chapter 2: Mechanical Installation

2.1

Introduction / Cut-out Details

The M850-LTHN MultiPower is designed for panel mounting and uses a standard 96mm x 96mm DIN case. It fits into standard 96mm DIN openings.

**Panel Cutout and Dimensions
of the M850-LTHN & M850-LTHN-RS-PO**
(shown in mm)

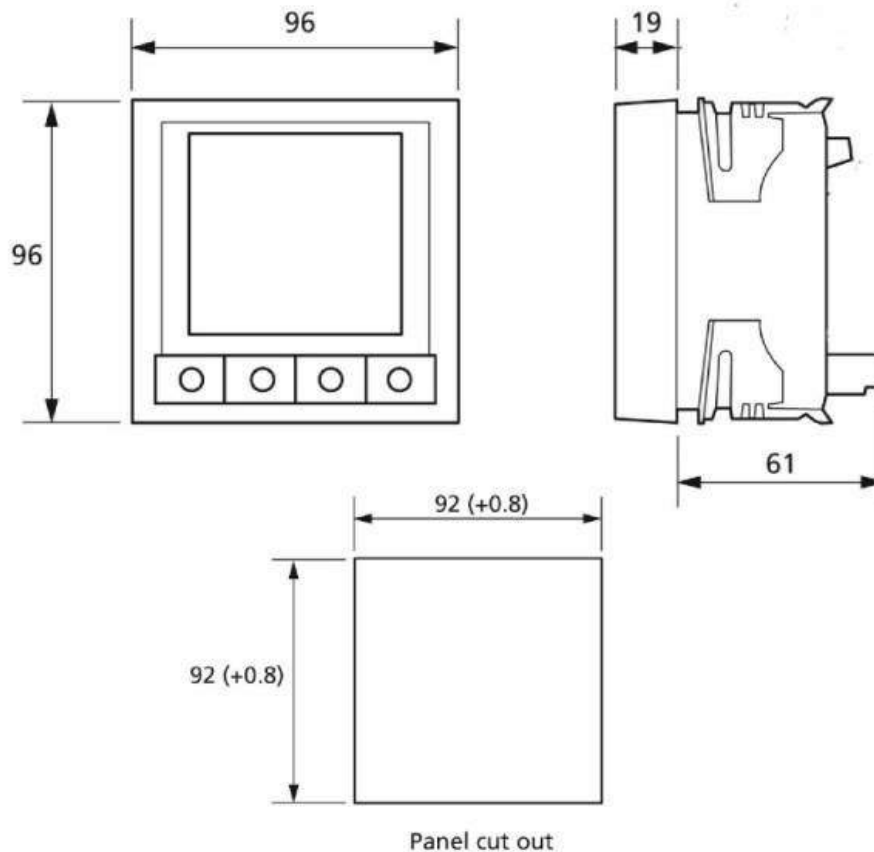

2.2

Panel Mounting Procedure

To install the M850-LTHN:

1. Remove the 4 retaining clips from the corners of the unit.
2. Insert the M850-LTHN from the front of the panel.
3. Slide the retaining clips back onto each corner of the meter and secure it to the back of panel. Push the clips until tight.

2.3

Terminal Block Notes:

Terminal screws are tightened using a flat-head screwdriver. It is recommended that the terminal screws be tightened by hand initially. When re-tightening with pneumatic screwdrivers, use a maximum torque of 0.5-1.0 Newton meters (Nm) or 1.1 in.-lbs.

Force greater than the recommended tightening torque will damage the terminal block and connection.

Connections of the M850-LTHN-RS-PO

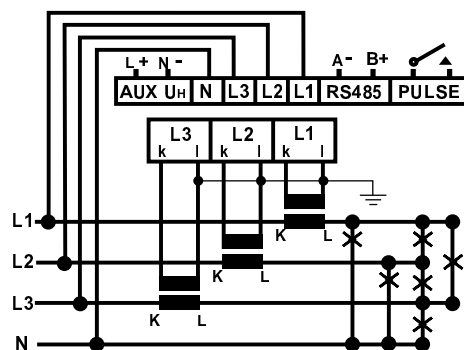
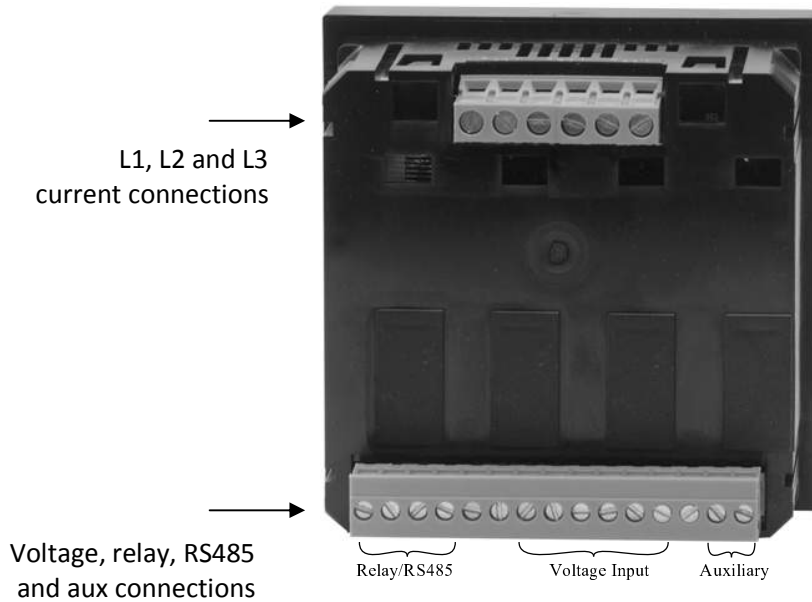

	Voltage				Current		
	L1	L2	L3	N	L1	L2	L3
1ph	✓	✗	✗	✓	✓	✗	✗
1ph 3W	✓	✓	✗	✓	✓	✓	✗
3ph 3W	✓	✓	✓	✗	✓	✗	✓
3ph 4W	✓	✓	✓	✓	✓	✓	✓
3ph 3W BAL	✓	✓	✓	✗	✓	✗	✗
3ph 4W BAL	✓	✗	✗	✓	✓	✗	✗

Unused Voltage terminals are internally connected
Secondary of CTs must be connected to earth

Chapter 3: Electrical Installation

3.1

Considerations When Installing Meters



It is recommended that wherever possible any/all equipment be installed, serviced, repaired or replaced in de-energized conditions. If this is not possible, then installation of the M850-LTHN must be performed by qualified personnel who follow all required safety precautions and procedures. They must have appropriate training, experience and/or professional certifications (where required) with high voltage devices. Appropriate personal protective safety equipment to meet all relevant standards is required by OSHA.

- During normal operation, dangerous voltages are present on parts of the M850 including: terminals and any connected current transformers (CTs) and potential transformers (PTs), all input and output modules and their circuits. All primary and secondary circuits should be regarded as capable of producing lethal voltages and currents. Avoid contact with any energized parts.
- DO NOT use the M850-LTHN for primary protection or in an energy-limiting capacity. The M850-LTHN is a power meter. DO NOT use the meter for applications where failure of the meter may cause harm or death. DO NOT use the M850-LTHN for any application where there may be a risk of fire.
- All meter terminals must be inaccessible to personnel in normal operation.
- DO NOT apply more than the maximum voltage the meter or any attached device can withstand. Refer to the M850-LTHN meter and/or device labels or see section 1.2 for meter specifications.
- DO NOT Hipot/dielectric test any outputs, inputs or communication terminals.



NOTE:

IF THE EQUIPMENT IS USED IN A MANNER NOT SPECIFIED BY THE MANUFACTURER,
THE PROTECTION PROVIDED BY THE EQUIPMENT MAY BE IMPAIRED.

- NOTE: THERE IS NO REQUIRED PREVENTATIVE MAINTENANCE OR INSPECTION NECESSARY FOR SAFETY. HOWEVER, ANY REPAIR OR MAINTENANCE SHOULD BE PERFORMED BY THE FACTORY.

3.2

Voltage Current and Power Supply Connections

All inputs are connected to the back of the unit via high contact pressure terminal blocks. The connectors accommodate up to AWG#12 / 2.5mm wire.

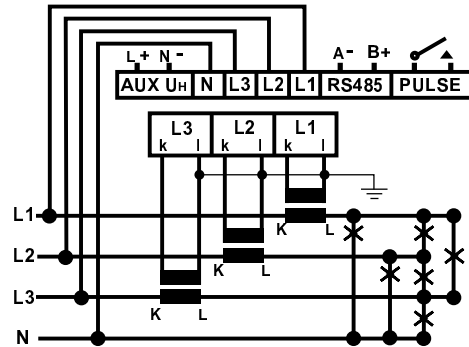

	Voltage				Current		
	L1	L2	L3	N	L1	L2	L3
1ph	✓	X	X	✓	✓	X	X
1ph 3W	✓	✓	X	✓	✓	✓	X
3ph 3W	✓	✓	✓	X	✓	X	✓
3ph 4W	✓	✓	✓	✓	✓	✓	✓
3ph 3W BAL	✓	✓	✓	X	✓	X	X
3ph 4W BAL	✓	X	X	✓	✓	X	X

Unused Voltage terminals are internally connected
Secondary of CT's must be connected to earth

APPLICABLE ELECTRICAL SYSTEMS

The M850-LTHN can be used on the following measured systems without any changes apart from wiring and programming configurations:

- Single Phase
- Single Phase, 3 Wire
- 3 Phase, 3 Wire balanced
- 3 Phase, 3 Wire unbalanced
- 3 Phase, 4 Wire balanced
- 3 Phase, 4 Wire unbalanced

Auxiliary Supply Note:

On models powered with AC auxiliary supply, the auxiliary supply can be connected in parallel with the measuring AC input voltage, but this restricts the measuring range of the input voltage to $\pm 15\%$ of nominal. If your application has a very wide range of AC measurement, the auxiliary supply should be from a different source.

Available auxiliary voltages on the M850-LTHN are:

- 100 to 440V,AC / 100 to 420V,DC (as standard)
- 19 to 69V,DC (optional extra)

Auxiliary voltage is rated from 45 to 65Hz (AC), with a burden of <10VA (AC or DC).

If the M850-LTHN is to be used on 400Hz system, then all connections to the meter has to be 400Hz, this meter will not work if Auxiliary supply is at 50Hz but the monitoring voltage and CT's are working at 400Hz.

3.3

Terminations to Meter

CURRENT TRANSFORMER CONNECTIONS:

Internally the M850-LTHN-RS-PO is either a 5 Amp, 1 Amp or 0.333mV rated. Current transformers must be attached externally. The current circuit is designed for connection to the secondary of external current transformers. These transformers should conform to at least Class 1 accuracy, or preferably ANSI C57.13 or equal.



Warning: The secondary of a current transformer must never be allowed to be in an open circuit condition when the primary is energized. In the open circuit condition high voltage may be present. Each current transformer secondary must be short-circuited when not connected to the meter.

VOLTAGE CONNECTIONS:

The secondary of these transformers must have the same nominal voltage as that specified on the data label on the side of the M850-LTHN.

The M850-LTHN standard input voltage is 28-330V,AC (L-N) and 48-570V,AC (L-L).

All connections must be made as shown ensuring all starts and finishes of current and voltage transformers are connected as shown.

3.4

Electrical Connection Diagram

Current Transformer and Wiring Connections Of the M850-LTHN

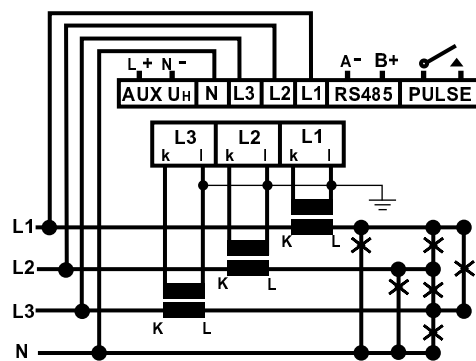

	Voltage				Current		
	L1	L2	L3	N	L1	L2	L3
1ph	✓	✗	✗	✓	✓	✗	✗
1ph 3W	✓	✓	✗	✓	✓	✓	✗
3ph 3W	✓	✓	✓	✗	✓	✗	✓
3ph 4W	✓	✓	✓	✓	✓	✓	✓
3ph 3W BAL	✓	✓	✓	✗	✓	✗	✗
3ph 4W BAL	✓	✗	✗	✓	✓	✗	✗

Unused Voltage terminals are internally connected
Secondary of CTs must be connected to earth

Chapter 4: Communications

4.1

Communications Overview

The M850-LTHN-RS-PO has an internal RS485 (MODBUS) communications card, as well as a pulsed output relay.

The RS485 communications card enables remote reading of up to 32 M850 units on a single 2-wire bus using the MODBUS protocol. The RS485 MODBUS protocol allows the M850-LTHN-RS-PO to be used with PC, PLC, RTU, Data loggers and SCADA programs.

If your system configuration requires communications with an Ethernet protocol, please use the M850-THD meter with the Ethernet plug-in option.

4.1.1

Optional USB to RS485 Adapter

Wire in the RS485 to USB adapter following the diagram in figure 4. Please note we do not supply the RS485 to USB converters.

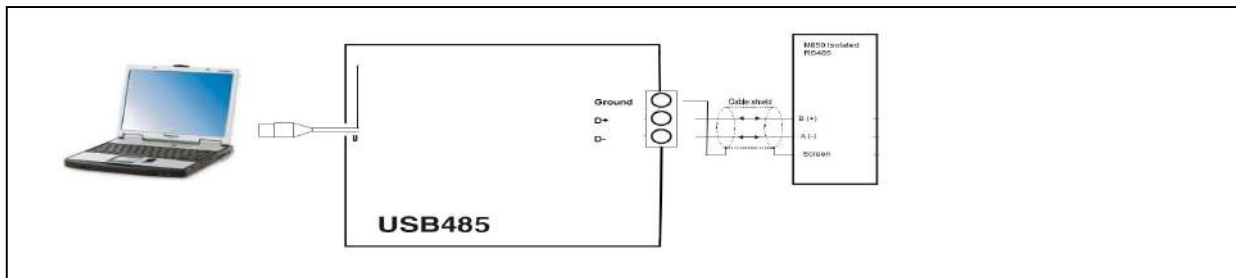

4.1.2

Pulsed Output Card

A pulsed output relay is also available. Pulses are supplied via a N/O Form A relay. The pulsed output can be assigned to W.h. or VAR.h. The relay can be set up via a sub-menu within the meter.

The pulse length of the relay can be set from a list provided in the menu (from 0 to 200 milliseconds). Pulses per hour (PPH) are modified using the decimal point positioning from the main screen.

4.2

Using the Communications Software

Software is available for use with the M850-LTHN-RS-PO via our website

Follow the instructions on the installation software.

4.2.1

Installation of USB-485 Device:

There are many types of USB to RS485 convertors in the market, most of the cheaper devices do not work, so make sure you select the correct one.

The device you have selected, will come with software or will be just plug and play, either way, follow the instruction provided to install all drivers necessary to operate the device.

Multiview and Multilog software:

1. Download and install the files
<http://www.hobut.co.uk/images/HOBUT-MViewV02.zip> for MultilogV02
<http://www.hobut.co.uk/images/MLogV2002.exe> for MultiView.
2. When starting the software, set the COM port and communications settings to the virtual COM port that was installed with the USB485 drivers.
3. The MultiView software should start communications with the M850 automatically if correct COM, the standard set-up screen for MultiView is shown below:



MultiView software will assist you in logging and downloading the electrical parameters captured with the M850-LTHN-RS-PO.

MultiLog software gives you the ability to view your voltage, current and power calculations with graphs and charts.

To access the MultiLog software, double-click the MultiLog icon that appears on your computer's desktop (or select it from your computer's hard drive.) Double clicking with the left mouse button on a graph will enlarge it or, if it's already full screen, will tile it. The right mouse button will enable a short-cut menu (below).

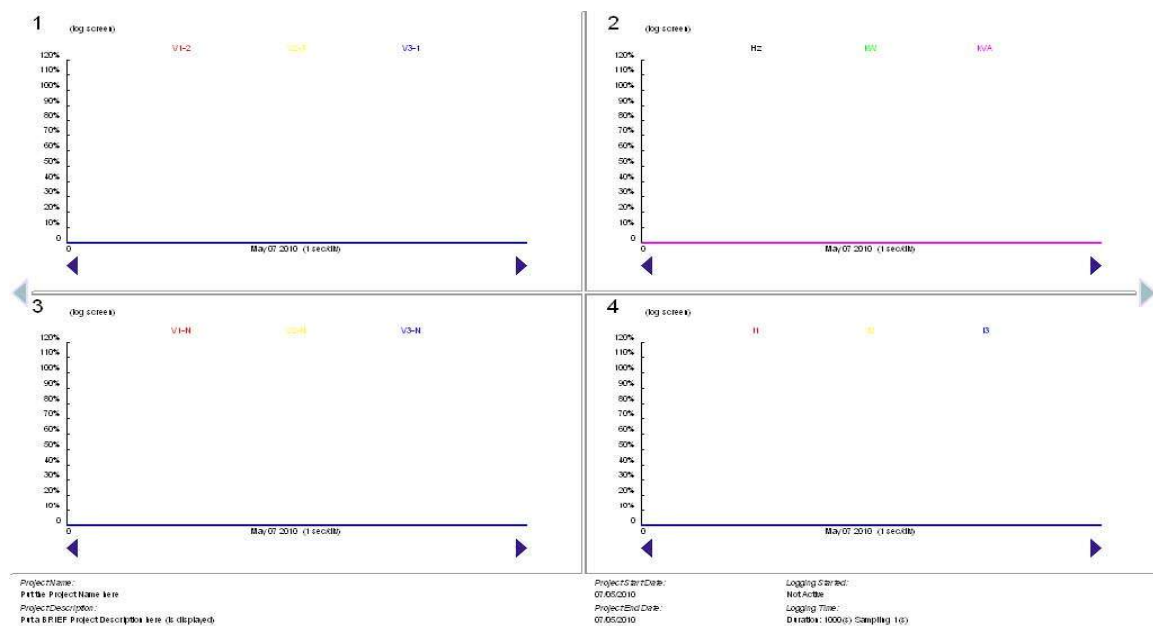

The first tab on the Project set up screen allows all the details of a project to be entered. Some of this can be displayed beneath the graphs.

The second tab is used to enter the logging parameters of a project to be entered.

The Graph Setup screen enables the user to tailor the graph screens. Logging screens can be mixed with Real Time screens provide you with up to 12 graphs, each having 3 traces.

The time base ranges from 5 to 600 seconds in real-time mode or 5 to 600 samples (minimum 1 second) in logging mode. Up to 7200 samples can be stored.

The Y axis can be relative 0-120% to enable displaying mixed signals, for example, 5A and 2000V on the same graph or absolute.

The Port Settings screen sets up the connection to the meter. NOTE: Ensure that the network settings are the same as those of the meter. If the meter's Comms Lock is disabled, successive tries to connect will result in the meter's network settings being changed.

The logged data can be exported as a comma separated variable file (.csv) for Excel to load. Emailing the saved file is also possible but the recipient must have a copy of MultiLog to view it.

4.3

Measurement Logging with MultiView

The measurements displayed in the Monitor/Log area of the MultiView program can be captured and saved to files. A choice of 1 to 6 channels can be selected from the drop-down menu, 'Measurements'. The order of the registers can be altered to make this set up more effective. See Register Order Function if none of the Trigger Points are enabled, all of the selected measurements are logged at the user-defined time period.

Trigger points can be set up (Over, Under and Window) to provide further flexibility and can be enabled or disabled using the associated 'Enabled' check box. When triggering is enabled, a further choice of whether to save only the triggering measurements (the measurements that fall outside the trigger points) or to record all the measurements regardless of which point caused the triggering.

The files saved will be Tab Separated Variable types suitable for pasting directly into Excel or similar program. There is no limit on the number of the files saved except for available disc space. (NOTE: this is not checked).

A file will have a base name, chosen by the user, and be limited in size to approximately 60,000 bytes. Subsequent files will also be limited to 60,000 and have a '-' and a consecutive number attached before its extension identifier. For example, if the file name selected for the log file is 'SystemVoltage.log', additional files will be System Voltage -2.log, System Voltage -3.log etc.

NOTE: The data will always be APPENDED to the last file of the specified name if the file or sequence of files already exists.

Logging Examples

All 6 values are logged at approx. 1 sec intervals.

No trigger points enabled.

Response Time = 300ms, Logging Period = 3, Measurements = 6

May 16 2003 13:23:39 500.0	V 1	230.0	V 2	230.0	V 3	230.0	I 1	500.0	I 2	500.0	I 3
May 16 2003 13:23:40 500.0	V 1	230.0	V 2	230.0	V 3	230.0	I 1	500.0	I 2	500.0	I 3
May 16 2003 13:23:41 500.0	V 1	230.0	V 2	230.0	V 3	230.0	I 1	500.0	I 2	500.0	I 3

The first 4 values are logged at approx. 1 sec intervals.

No trigger points enabled.

Response Time = 300ms, Logging Period = 3, Measurements = 4

May 16 2003 13:30:19	V 1	230.0	V 2	230.0	V 3	230.0	I 1	500.0
May 16 2003 13:30:20	V 1	230.0	V 2	230.0	V 3	230.0	I 1	500.0
May 16 2003 13:30:21	V 1	230.0	V 2	230.0	V 3	230.0	I 1	500.0

V1, V2 and I1 trigger points are enabled and sampled at approx. 1 sec intervals.

Response Time = 300ms, Logging Period = 3, Measurements = 4, No triggering occurred.

V1, V2 and I1 trigger points are enabled and sampled at approx. 1 sec intervals.

Response Time = 300ms, Logging Period = 3, Measurements = 4

Triggering occurred on V1 (over) and all measurements logged.

May 16 2003 13:53:41	V 1	242.0	V 2	242.0	V 3	242.0	I 1	500.0
May 16 2003 13:53:42	V 1	242.0	V 2	242.0	V 3	242.0	I 1	500.0
May 16 2003 13:53:43	V 1	242.0	V 2	242.0	V 3	242.0	I 1	500.0

Triggering occurred on V2 (under) and all measurements logged.

May 16 2003 13:54:13	V 1	210.0	V 2	210.0	V 3	210.0	I 1	500.0
May 16 2003 13:54:14	V 1	210.0	V 2	210.0	V 3	210.0	I 1	500.0
May 16 2003 13:54:15	V 1	210.0	V 2	210.0	V 3	210.0	I 1	500.0

Triggering occurred on I1 (window-over) and all measurements logged.

May 16 2003 13:59:40	V 1	230.0	V 2	230.0	V 3	230.0	I 1	610.0
May 16 2003 13:59:41	V 1	230.0	V 2	230.0	V 3	230.0	I 1	610.0
May 16 2003 13:59:42	V 1	230.0	V 2	230.0	V 3	230.0	I 1	610.0

Triggering occurred on I1 (window-under) and all measurements logged.

May 16 2003 13:59:57	V 1	230.0	V 2	230.0	V 3	230.0	I 1	100.0
May 16 2003 13:59:58	V 1	230.0	V 2	230.0	V 3	230.0	I 1	100.0
May 16 2003 13:59:59	V 1	230.0	V 2	230.0	V 3	230.0	I 1	100.0

V1, V2 and I1 trigger points are enabled and sampled at approx. 1 sec intervals.

Response Time = 300ms, Logging Period = 3, Measurements = 4

Triggering occurred on V1 (over) and only error measurements logged.

May 16 2003 14:03:55	V 1	242.0
May 16 2003 14:03:56	V 1	242.0
May 16 2003 14:03:57	V 1	242.0

Triggering occurred on V2 (under) and only error measurements logged.

May 16 2003 14:04:11	V 2	210.0
May 16 2003 14:04:12	V 2	210.0
May 16 2003 14:04:13	V 2	210.0

Triggering occurred on I1 (window-over) and only error measurements logged.

May 16 2003 14:04:30	I 1	610.0
May 16 2003 14:04:31	I 1	610.0
May 16 2003 14:04:32	I 1	610.0

Triggering occurred on I1 (window-under) and only error measurements logged.

May 16 2003 14:04:41	I 1	100.0
May 16 2003 14:04:42	I 1	100.0
May 16 2003 14:04:43	I 1	100.0

4.4

Network Description

In this section, we use the following words to describe:

NODE: a network device, typically a PLC, PC, instrument or transducer.

MASTER: a NODE which controls the protocol of a MASTER-SLAVE network.

SLAVE: a node which responds to specific requests from a MASTER node.

ADDRESS: a node's unique network identifier in the range of 1-247.

PACKET: a string of bytes transmitted sequentially across a network.

FIELD: a byte or sequence of bytes within a packet of data.

CYCLIC REDUNDANCY CHECK (CRC): a packet's error check value.

PROTOCOL: a set of rules or a procedure.

A node's unique address allows the master to selectively request data from a specific node. The master node, under the control of a program, requests measurements from one of its slave nodes using an established protocol.

For more information on the MODBUS protocol and to download relevant literature, go to <http://www.MOVBUS.org> and click on "MODBUS Standard Library".

Format

- Up to five baud rates are supported (not all units) 76800, 57600, 38400, 19200, 9600, and 4800.
- Bit transfer rates for 1 bit of data are 26us, 52us, 104us, 208us and 417us respectively.
- The format, as specified by MODBUS, is a constant 11 bits per byte transmitted and received, consisting of 1 start bit, 8 data bits, 1 parity bit and 1 stop bit.
- If NO parity bit is used there should be an extra stop bit inserted in its place (i.e. 1 start bit, 8 data bits and 2 stop bits).

Note: In more recent units a format of 10 bits is supported, i.e. 1 start bit, 8 data bits, NO parity bit and 1 stop bit.

4.5

Measurement Registers (3X and duplicated 3X)

Sample Coding

Slave Address = 1

Reading 6, 3X Registers - code 4

V1 = **239.9V**, V2 = 239.7V, V3 = **239.7V**

I1 = 499.8A, I2 = **499.3A**, I3 = 499.3A

Start Address = 6, number of WORD registers required = 12 (0C hex)

Number of values returned = 6, 32 bit floating point (24 bytes)

Message Packet To SLAVE

01 04 00 06 00 0C 10 0E

Response Packet From SLAVE

01 04 18 **43 6F E2 28** 43 6F A9 C8 **43 6F A9 C8** 43 F9 E0 E9 **43 F9 A6 31** 43 F9 A6 31 EC 6D

See Appendix A for the MODBUS Registers. These list the parameters with the MODBUS equivalent address and its address within the M850-LTHN-RS-PO. Any data requested that isn't applicable to the Type & System column, will return the value -ve infinity (FFFFFFFFh). The order can be altered using the MultiView Program supplied or by a suitable SCADA program.

Retrieving Measurements

The measurement registers in the instrument are stored as 32-bit (4 byte) [IEEE754](#) floating point numbers. Each is arranged as 2, 16-bit words; hence the evenly numbered real Start Addresses in the tables in this document. The standard word order on this product is low word – high word.

The word order can be changed to any of the following settings using either the front button menu or MODBUS via the Multiview software. The standard order for most U.S. based PLC's and HMI's is Big Endian High word – Low word.

Big Endian (Motorola)	Low word - High Word
Little Endian (Intel)	Low word - High word
Big Endian (word Swap)	High word - Low word **
Little Endian (word Swap)	Low word - High word**
Word Swap	as above but the bytes within each word are swapped with each other.

**Available only on the latest firmware. Firmware can be re-flashed by PC&S, please call for information.

The MODBUS protocol dictates the retrieval of data as 2 bytes (one word) at a time. To accommodate MODBUS register addressing when the registers are 4 bytes wide, the data has to be retrieved in double words. MODBUS registers in this case are merely pointers to real addresses within an instrument whether the data at that address is 2, 4 or 8 bytes wide. This makes programming a controller simpler in so far that a pointer can be a word, double or float type and essentially the code to retrieve data from a node remains the same.

The SLAVES require data start ADDRESSES on even numbered register locations and will reject odd numbers and return an exception code.

The SLAVES require the number of DATA words requested in multiples of 2 and will reject odd numbers and return an exception code.

Example 1

Volts L2-L1 - MODBUS Address 30001 (Reg. Start Address 0000h)

The implied address of this measurement is 30001. The actual register addresses in the SLAVE are **0000h**, containing the most significant bits of the floating point measurement and **0001h**, containing the least significant bits of the floating point measurement. Both of these registers are 16 bits wide.

Example 2

Volts L3-L2 - MODBUS Address 30002 (Reg. Start Address 0002h)

The implied address of this measurement is 30002. The actual register addresses in the SLAVE are **0002h**, containing the most significant bits of the floating point measurement and **0003h**, containing the least significant bits of the floating point measurement. Both of these registers are 16 bits wide.

To calculate the correct register offset within the SLAVE and the correct number of registers to retrieve, use the following formula:

((MODBUS implied 3x start address - 30001)*2) for the register start address.
(Number of measurements required x 2) for registers required.

Packet Structure

A packet of data transmitted by a MASTER node will look something like the following example:
[Address (1 byte)][Function Code (1 byte)][Register Start Address (2 bytes)][Number of Registers Required (2 bytes)][CRC error check (2 bytes)]

Request the measured voltages of a meter (MODBUS addresses 30004 to 30006) from SLAVE 2.
MODBUS address 30004 = Meter address (30004 - 30001) * 2 = 6 = 06h

The packet to send will be,

[02][04][0006][0006][CRC][CRC]

The packet returned will be,

[02][04][0C][12 bytes of data (three [floating point](#) measurements)] [CRC][CRC]

Sample Coding:

READ

Slave Address = 1

Reading 6, 3X Registers - code 4

V1 = **239.9V**, V2 = 239.7V, V3 = **239.7V**

I1 = 499.8A, I2 = **499.3A**, I3 = 499.3A

Start Address = 6, number of WORD registers required = 12 (0C hex)

Number of values returned = 6, 32 bit floating point (24 bytes)

Message Packet To SLAVE

01 04 00 06 00 0C 10 0E

Response Packet From SLAVE

01 04 18 **43 6F E2 28** 43 6F A9 C8 **43 6F A9 C8** 43 F9 E0 E9 **43 F9 A6 31** 43 F9 A6 31 EC 6D

WRITE

Slave Address = 1

Writing To 4X Registers - code 16 (10 hex)

Changing system Voltage to 220V

Message Packet To SLAVE

01 10 00 00 00 02 04 **43 5C 00 00** 26 39

NOTE: 43 5C 00 00 = 220

Response Packet From SLAVE

01 10 00 00 00 02 41 C8

4.5.1

3X Registers

Internally, the M850 3X Registers are duplicated in the 4X Register area from address 41001, (internal register offset 2001 (07D1h)). This allows PLCs that can't read floating point data in the 3X area to retrieve the measurements from the 4X area. See Appendix A for a list of the MODBUS Registers.

- The registers are listed with their MODBUS addresses
- The data held at these addresses are Read-Only
- 3X registers are read using function 04h
- 4X registers are read using function 03h

A sample read packet using code 4 to access the 3X registers will look like this:
[Node][04][start address][No. of Double Registers Requested][CRC(2 bytes)]

e.g. To read line to neutral voltages on node 23h:
[23h][04h][0006h][0006h(3, 4 byte regs)] [CRC(2 bytes)]

The node's return packet will look like:

[23h][04h][0Ch][12 bytes of data = 3 floating point numbers] [CRC(2 bytes)]

A sample read packet using code 3 to access the 4X registers will look like this:
[Node][03][start address][No. of Double Registers Requested][CRC(2 bytes)]

e.g. To read line to line voltages on node 23h using the duplicated measurements in the 4X area:
[23h][03h][07D0h][0006h(3, 4 byte regs)] [CRC(2 bytes)]

The node's return packet will look like:

[23h][03h][0Ch][12 bytes of data = 3 floating point numbers] [CRC(2 bytes)]

See Appendix A for a default order of the 3X registers in the M850. The order can be altered using the System Monitor program, supplied on request, or by using a suitable SCADA program.

3X Register Re-Ordering

The M850 has the facility to re-order its [MODBUS 3X](#) registers to suit an existing MODBUS network. The integrated register re-ordering function ('Registers' button) in the [System Monitor](#) Program provides an easy method of achieving this.

If System Monitor isn't going to be used, MODBUS function code 42h (66) can be used to request this data and MODBUS function code 41h (65) can be used to send a string of data to set the order of the registers. The order will automatically be saved in FLASH.

UNLIKE THE 3X AND 4X REGISTERS, THESE DATA ARE WORD WIDE INTEGER.

It is important to remember that each register in the packet's data field contains two references to the registers to be re-ordered.

A sample read packet will look like this:

[Node][42][start address(**always 0000h**)][No. of Double Registers Required][CRC(2 bytes)]

e.g. To read the 41 MODBUS registers in node 23h a request to send 21 (15h) registers is made:
[23h][42h][0000h][0015h][CRC(2 bytes)]

A sample write packet will look like this:

[Node][41][start address(**always 0000h**)][No. of Double Registers][Data length in bytes] [REGISTERS][CRC(2 bytes)]

e.g. To set the 41 MODBUS registers to their default order in node 23h:

[23h][41h][0000h][0015h][29h][0102h][0304h][0506h][0708h][090Ah][0B0Ch][0D0Eh]
[0F10h][1112h][1314h][1516h][1718h][191Ah][1B1Ch][1D1Eh][1F20h][2122h]
[2324h][2526h][2728h][29xx][CRC(2 bytes)]

Note: xx = don't care

Sample Coding:

WRITE

1) Set the default order

Slave Address = 1

Writing - code 65 (41 hex)

Message Packet To SLAVE

01 41 00 00 00 15 29 01 02 03 04 05 06 07 08 09 0A 0B 0C 0D 0E 0F 10 11 12 13 14 15 16 17 18 19 1A 1B 1C
1D 1E 1F 20 21 22 23 24 25 26 27 28 29 6E 58

Response Packet From SLAVE

01 41 00 00 00 15 FC 0A

2) Move registers W Sum (position 10), VAr Sum (position 12) and VA Sum (position 11) into the first three positions in the table so that the measurements can be retrieved from the slave by reading just the first three registers (30001-30003 or 42001-42003).

Slave Address = 1

Writing - code 65 (41 hex)

Message Packet To SLAVE

01 41 00 00 00 15 29 0A 0C 0B 01 02 03 04 05 06 07 08 09 0D 0E 0F 10 11 12 13 14 15 16 17 18 19 1A 1B 1C
1D 1E 1F 20 21 22 23 24 25 26 27 28 29 74 1E

Response Packet From SLAVE

01 41 00 00 00 15 FC 0A

READ

Note: Asking for more registers than the M850 supports will not result in an error. A read command will always return the maximum number of registers.

Send relay channel's parameters (function 103)
Send 8, 16 byte structures.

Note: Only the first two structures are used by the M850

Format:

[node number][67h][register start(2 bytes)][number of registers(2 bytes)][number of bytes]
[<-8, 16 byte structures + 1 relay actions + 1 padding byte (130 (82h) bytes of data)->][crc(2 bytes)]

One of the 8, 16 byte structures to send to the M850 is defined below.

Byte #	Name	Usage Type
0	N/A (send NULL)	unsigned char
1	N/A (send NULL)	unsigned char
2	Energy Relay (send 254)	char
3	N/A (send NULL)	char
4	N/A (send NULL)	char
5	N/A (send NULL)	char
6	N/A (send NULL)	unsigned int
8	N/A (send NULL)	unsigned int
10	N/A (send NULL)	char
11	ID value (15 = W.h, 16 = VAr.h)	char
12	N/A (send NULL)	char
13	Relay Number (1 or 2)	char
14	Relay Divisor (0 = /1, 1 = /10, 2 = /100, 3 = /1000)	char
15	Relay Pulse Width (0 = OFF, 2 to 10 = 20ms to 200ms)	char

In addition to sending the 8 structures, two bytes must be appended to the packet.

1st Byte:

A one-byte bit pattern, where each bit is mapped to one physical relay,
(bit 0 = Relay 1, bit 1 = Relay 2 etc.)

If a bit is reset (0), the corresponding relay's function is to operate at pulse time.

If set (1) it will release.

2nd Byte:

This is a NULL byte for padding and is ignored.

Retrieve relay channel's parameters (code 104)

Requests 8, 16 byte structures representing the parameters for the energy relay(s).

Only the first two structures are valid.

Format:

[node address][68h][register start(2 bytes)][number of registers(2 bytes)][crc(2 bytes)]

One of the 8, 16 byte structures read from the M850 is defined below.

Byte #	Name	Usage Type
0	N/A	unsigned char
1	N/A	unsigned char
2	Energy Relay (254)	char
3	N/A	char
4	N/A	char
5	N/A	char
6	N/A	unsigned int
8	N/A	unsigned int
10	N/A	char
11	ID value (15 = W.h, 16 = VAr.h)	char
12	N/A	char
13	Physical Relay Number of attached relay	char
14	Relay Divisor (0 = /1, 1 = /10, 2 = /100, 3 = /1000)	char
15	Relay Pulse Width (0 = OFF, 2 to 10 = 20ms to 200ms)	char

In addition to receiving the 8 structures, two bytes will be appended to the packet.

1st Byte:

This is a one-byte bit pattern where each bit is mapped to one physical relay.

If a bit is reset (0), the corresponding relay's function is to operate on exceptions. If set (1) it will release.

READ/WRITE

The M850 relay's action (energize or de-energize) at pulse time can be written/read using the table below.

The format is a one-byte bit pattern, where each bit is mapped to one physical relay (bit 0 = Relay 1, bit 1 = Relay 2)

At pulse time, if a bit is reset (0), the corresponding relay's function is to energize, if set (1) it will de-energize.

Example:

An M850 has two relays installed and these are numbered RLY1 and RLY2.

By default, they correspond to bit positions 0 and 1 respectively. The rest of the bits (2 - 7) in the actions byte are ignored.

Relays	2	1
Bit No.	1	0
Action Byte	0	1
Action at pulse time	De-energize	Energize

If a bit is reset (0), the corresponding relay's function is to operate on exceptions. If set (1) it will release.

2nd Byte:

A NULL byte for padding.

Function 104 Coding Example

Request relay(s) channel's parameters from node 1.

All eight structures are requested but only the first two are valid.

Format:

[node address][68h][register start(2 bytes)][number of registers(2 bytes)][crc(2 bytes)] [01][68][0000][0041][A033]

Returned relay(s) channel's parameters

Format:

[node number][68h][register start(2 bytes)][number of registers(2 bytes)][number of bytes][<-8 structures + 1 relay actions + 1 padding byte (130 (82h) bytes of data)->][crc(2 bytes)]
[01][68][0000][0041][82]

[64 05 FE 00 01 01 00 00 00 00 01 0E FE 01 00 0A]
[64 05 FE 00 01 01 00 00 00 00 01 10 FE 02 00 0A]
[64 05 00 00 01 03 00 00 00 00 01 00 00 00 0A]
[64 05 00 00 01 03 00 00 00 00 01 00 00 00 0A]
[64 05 00 00 01 03 00 00 00 00 01 00 00 00 0A]
[64 05 00 00 01 03 00 00 00 00 01 00 00 00 0A]
[64 05 00 00 01 03 00 00 00 00 01 00 00 00 0A]
[64 05 00 00 01 03 00 00 00 00 01 00 00 00 0A]
[00][FF][5B62]

* In 3 wire mode system V1, V2, V3 will have the same value as volts L2-L1, L3-L2, L1-L3.

**M850-LTHN-RS-PO only measures import W.h and VAr.h

4.5.2

4X Registers

The registers are listed with their MODBUS addresses. See Appendix A for a complete list of 4X Registers. The data held at these addresses are Read-Only, Write-Only or Read+Write, as indicated below.

4X registers are read using function 03h and written using function 10h.

A sample write packet will look like this:

[Node][10][start address][No. of Double Registers][Data length in bytes][CRC(2 bytes)]

e.g. To set Node 23h Primary Voltage and Secondary Voltage together:

[23h][10h][001Ch][0004h(4, 2 byte regs)][08h(2, 4 byte regs)][CRC(2 bytes)]

READ

Packet from master format :

[Node addr][03][Register start addr.(2 bytes)][No of reg(2 bytes)][CRC (2 bytes)]

Response from Slave format :

[Node addr][03][Byte count][Data(byte count bytes)][CRC(2 bytes)]

Function 16 (10 hex) - Preset Multiple registers (4X)

These registers contain the system settings and controls. Register addresses in the M850-LTHN-RS-PO at 0, but in keeping with Modicon MODBUS codes, are designated addresses starting 40001.

See Appendix A for a default order of the 4X Registers in the M850. The order can be altered using the System Monitor program, supplied on request, or by using a suitable SCADA program.

M850 Supported MODBUS Codes

Read Holding (4X) Registers (code 3)

Returns a specified number of consecutive system registers.

Read Input (3X) Registers (code 4)

Returns a specified number of consecutive measurement registers.

NOTE: the measurement registers are duplicated (mapped) into the 4X area.

Pre-set Multiple Holding (4X) Registers (code 16)

Writes data to a specified number of consecutive system registers.

Report Slave ID (code 17)

This function returns the status of an instrument, the returned packet consists of 14, four byte floating point numbers. (IEEE754)

Register Order (codes 65 and 66)

The register order can be written or read using the above codes.

Send relay channel's parameters (code 103)

Send 8, 16 byte structures representing the parameters for the 8 conditions that can be attached to each relay installed. NOTE: only the first two channels are applicable but all 16 have to be sent.

Read relay channel's parameters (code 104)

Requests 8, 16 byte structures representing the parameters for the 8 conditions that can be attached to each relay installed. NOTE: only the first two channels are applicable but all 16 will be read.

Exception Codes

A normal response from a slave is the echoing of the function code and the supplying of the data that is requested.

Exceptions are reported in the response from a slave node by setting the msb of the function code and inserting the applicable error code in the data field. Only the last example below will result in an exception being reported to the master node.

- If the slave does not receive the query due to a communication error, no response is returned. The master node will eventually process a time-out condition for the query.
- If the slave receives the query, but detects a communication error (parity or CRC), no response is returned. The master program will eventually process a time-out condition for the query.
- If the slave receives the query without a communication error but cannot handle it (e.g. a request to read a non-existent register), the slave will return an exception response informing the master of the nature of the error.

The error codes that could be returned in the data field are:

- 01 - Illegal or Unknown Function
- 02 - Illegal Data Address
- 03 - Illegal Data value

4.6

M850-LTHN-RS-PO Communication and Programming Overview

Communication Format

Baud rate: 4800, 9600, 19200, 38400, 57600 and 76800

Low level character format:

- With Odd or Even parity = 1 start bit, 8 data bits, 1 parity bit, 1 stop bit
- With NO parity = 1 start bit, 8 data bits, 2 stops bits.

MODBUS Format

Data format: RTU

32 bit, floating point format to IEEE-754 standard, exponent bias 127, most significant byte transmitted first. There is no word reversal.

Address range: 1-247

Error Check:

Cyclic Redundancy Check (CRC), Polynomial exclusive OR value A001h Low byte sent first.

MODBUS Protocol

Only the RTU (Remote Terminal Unit) form of the MODBUS protocol will be supported and all references in this sheet refer to RTU format.

Typically, the master or controller requests data from its slaves by polling them one at a time and waiting for a pre-defined amount of time for a response. If a node doesn't respond within this time period the master will try accessing it a further two times before indicating to the SCADA system that the node has gone off-line or there is a fault with it. If all is well the node will respond with the data requested.

A typical communication 'packet' will be in the form:

[Node Address] [Function] [Byte count, Data etc.] [Error check]

Because MODBUS is a word (2 byte) orientated protocol, floating point (4 byte) register numbers are counted in multiples of two.

register 1	= start address 0
register 2	= start address 2
register 3	= start address 4
register 4	= start address 6
Formula	= (register required -1) x2

This also applies to the number of registers requested. If 2 registers are requested the number of WORDS in the packet's [Number of registers] slot should equal 4.

Chapter 5: Using the M850-LTHN Meter

5.1

Introduction

All units can be fully programmed by the factory but there are many features that can be programmed by the User to suit individual applications and needs. Programmed values and parameters are stored in non volatile memory and are therefore retained in power down situations.

To enter the programming mode, simultaneously press the two front buttons 'I' and 'E'. Keep them pressed and held for 5 seconds.

The M850-LTHN now enters the setup mode SUPP. This mode allows the User to set the parameters such as Current ratio, voltage ratio, type of systems etc. This meter does not have the option of selecting a customized screen, all screens are fixed to the buttons.

NOTE

When in programming mode, if the control buttons are not used for more than 6 minutes M850-LTHN returns to the measuring mode and displays the first screen.

5.1.1

Meter Face Elements

The face of the M850-LTHN-RS-PO contains a LCD display designed to be read in a variety of conditions. Four, easy-to-access, front control buttons are used for scrolling up and down through the parameters.

The user can measure a standard range of 19 different electrical parameters by scrolling through the buttons on the front of the panel.

The LCD display has a range of 0000 to 9999. Each of the LCD numerals measures 0.56" and has an update time of 1 second. Decimal selection is defined by the user or the meter based on the current transformer and or voltage transformer ratio, the decimal points can be shown as X●X●X●X●. Polarity is always assumed positive on the display.

5.1.2 Display Screens

Each screen is displayed by pressing one of the four front panel buttons:

- 'I' for Current
- 'V/Hz' for Voltage and Frequency
- 'P' for Power and
- 'E' for Energy

Display Screens of the M850-LTHN

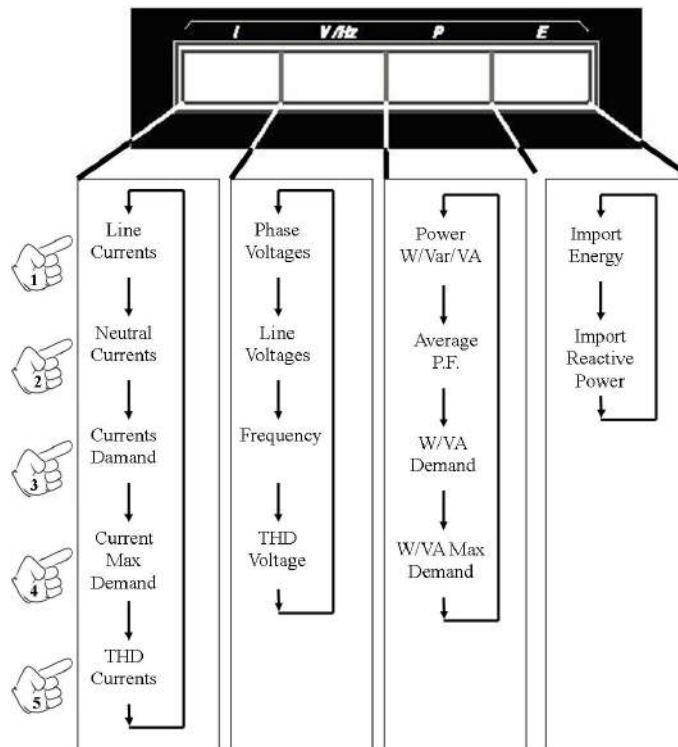

Press the 'I' button to access measurements on Current. One press of the button displays line currents; two presses of the button displays neutral current; three presses displays current demand; four presses of the 'I' button displays current maximum demand; five presses of the button brings the user back to the top of the category listing (in this instance.)

Each press of the button steps the user to the next measurement.

Appendix C shows all of the main menu and sub-menu screens.

LCD Brightness adjustment:

It is possible to adjust the brightness on the M850-LTHN display by:

1. Hold down the two center buttons ('V/Hz' and 'P') simultaneously on the front panel.
2. The brightness level will adjust as the buttons are held down.
3. Each individual press of the buttons steps to the next level of brightness, up to 8 levels of brightness available.

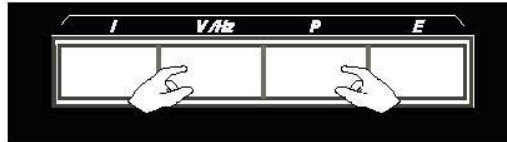

Change the Colour of the Screen:

It is also possible to change the colour of the screen on the M850-LTHN.

1. To adjust the screen colour, press and hold 'I' and 'P' simultaneously for 10 secs (choice of 3 colours to choice from White, Green or Blue)

5.2

Settings Menu

The main Settings menu is accessed on the M850-LTHN by holding down the 'I' and the 'E' buttons simultaneously. The main menu, and all sub-menus, are scrolled through using the 'E' button. Any selection is made using the 'I' button. If no buttons are pressed for 6 minutes, the M850-LTHN will exit the Settings menu.

There are 8 sub-menus: Supply; Communications (485); Demand; Energy; Relay; Code; EEPROM; and, End. The unit will cycle through each sub-menu screen as the User pushes the 'E' or 'I' button.

See Appendix C for the various programming sub-menu screens you will see as you program the M850-LTHN.

The Settings Menu structure is shown below:

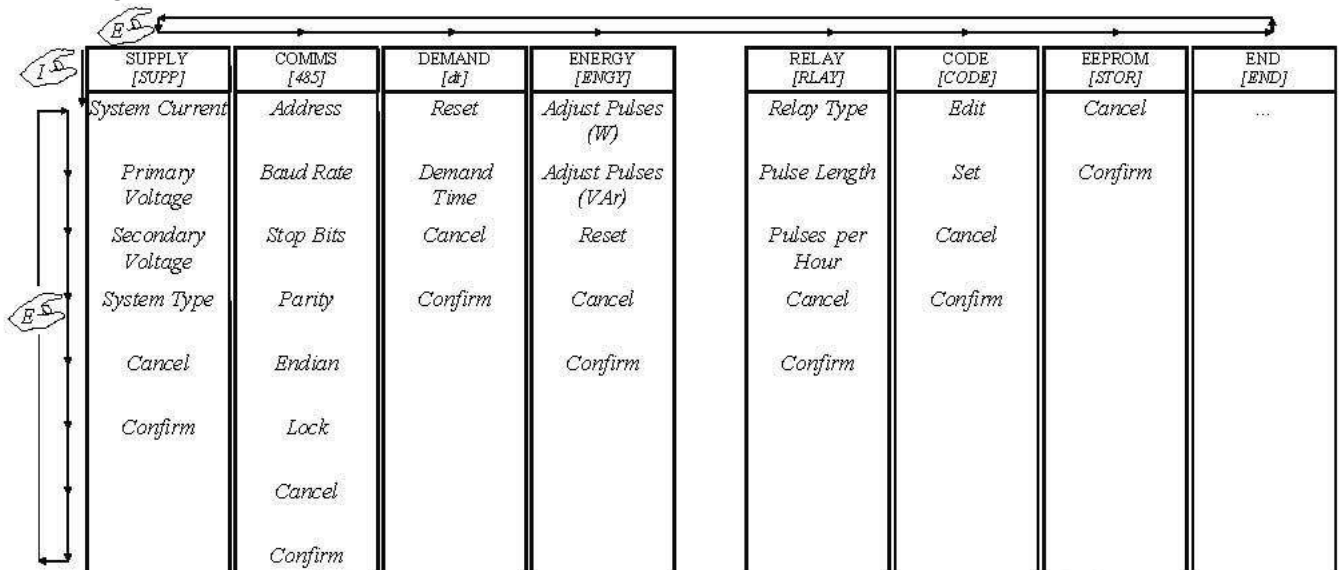

The following abbreviations are displayed on the sub-menu screens when the M850 is in Setting Menu mode:

Display	Indicates
ADDR	Address for communications
ADJ (VAr)	Adjust Pulses (VAr)
ADJ (W)	Adjust Pulses (Power)
BAUD	Baud Rate
CNCL	Cancel any changes
CODE	Password Code
COMMS	RS485 network setting
CONF	Confirm any changes
DT	Demand
DTST	Demand Time Set Value
EDIT	Edit Pass Code
END	End main menu
ENDI	Endian
ENGY	Energy
LOC	Lock
PAR	Parity
PPH	Pulses per Hour
PULS LNTH	Pulse Length
RLAY	Relay
RST	Reset
SET	Set Pass Code
STOP	Stop Bits
STOR	EEPROM sub-menu
STOR	Store to EEPROM
SUPP	Supply
SYSA	System Current
TYPE	System Type
UPRI	Primary Voltage
USEC	Secondary Voltage

At the end of most sub-menus is the option to CANCEL any changes made in that sub-menu. In addition, confirmation is required before any changes are implemented. The CONFIRM button within the sub-menu screens should be selected to confirm the changes. The changes are effective as soon as they are confirmed.

CANCEL or CONFIRM must be pressed to return to the sub-menu title (i.e. SUPP, 485, etc.)

5.2.1 Supply (SUPP) Sub-Menu

This sub-menu contains screens for monitoring: System Current; Primary Voltage; Secondary Voltage; System Type; Canceling and Confirming actions made within this section.

The VT (or PT) ratio and the system current are entered using this sub-menu. The secondary voltage (meter input) is optimized at 280V (L-N). Decimal point positioning and exponent selection are used in this section.

The system's type is selected from the following list:

Unbalanced	
1P2	1 phase 2 wire
3P3	3 phase 3 wire
3P4	3 phase 4 wire
1P3	1 phase 3 wire
Balanced	
3P3B	3 phase 3 wire
3P4B	3 phase 4 wire

When entering data, numbers can be entered into the unit in the following way:

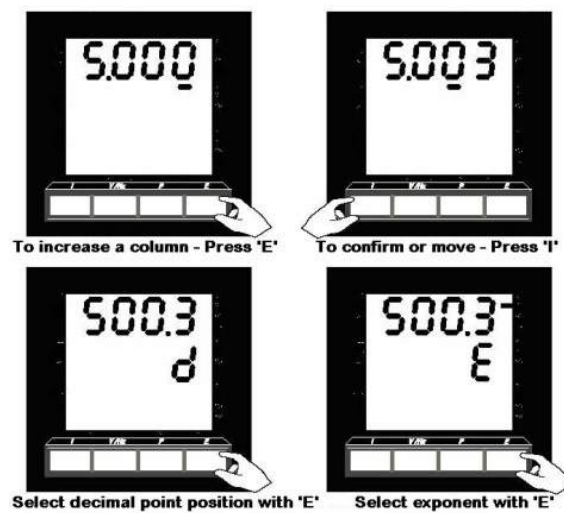

See Appendix C.2 for the SUPPLY programming screens.

5.2.2

Communications (485) Sub-Menu

This sub-menu contains screens for monitoring: Communications Address; Baud Rate; Stop Bits; Parity; Endian; Lock; Canceling and Confirming actions within this section.

When using the plug-in RS485 (MODBUS protocol) option, the network settings can be detected and the unit configured automatically. If manual configuration is preferred, the meter can be set up as follows:

Baud rate	
4.8	4800 baud
9.6	9600 baud
19.2	19,200 baud
38.4	38,200 baud
57.6	57,600 baud
76.8	76,800 baud
Stop Bits	
0	No stop bits
1	1 stop bit
2	2 stop bits
Parity	
N	No parity bit
O	Odd parity bit
E	Even parity bit

The unit's baud rate, number of stop bits and parity can be selected from the list above. Floating point numbers can be transmitted in either Big Endian (default) or Little Endian BYTE order. They can be selected using the Endian items, as follows:

Big Endian (Motorola)	Low word – High word
Little Endian (Intel)	Low word – High word
Big Endian (word Swap)	High word – Low word**
Little Endian (wor Swap)	High word – Low word**

** Available only on the latest firmware. Firmware can be re-flashed by PC&S, please call for information.

Locking prevents the unit hunting for a valid network if communication errors are occurring and can be set using the LOCK item. See Appendix C.3 for the COMMUNICATIONS programming screens.

When entering data, numbers can be entered into the unit in the following way:

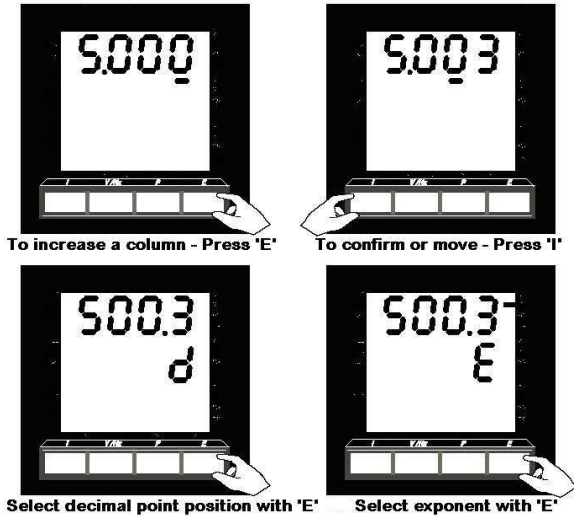

When only fixed data can be entered, you can select the values from the list:

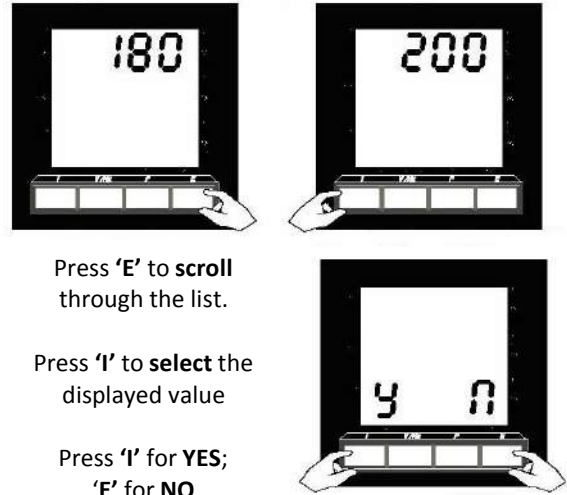

5.2.3 Demand (DT) Sub-Menu

This sub-menu contains screens for: Reset; Demand Time; Canceling and Confirming actions within this section.

The unit integrates all measurement of Amps, Power and VA within a variable time length sliding window. The Reset option will reset all demand and maximum demand measurements.

The Demand Time window can be set to a value of between 3 and 60 minutes (inclusive).

When entering data, numbers can be entered into the unit in the following way:

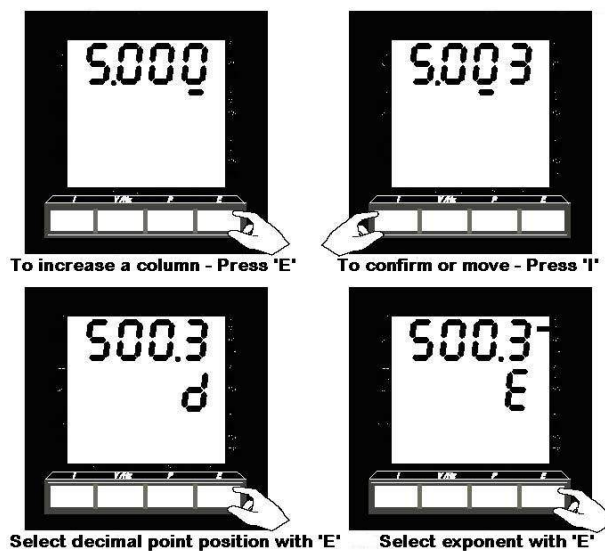

See Appendix C.4 for the DEMAND programming screens.

**5.2.4
Energy (ENGY) Sub-Menu**

This sub-menu contains screens for: Adjust Pulses (W); Adjust Pulses (VAR); Reset; Canceling and Confirming actions within this section.

There are two energy accumulators in the unit: Import Power and Import VAR. Modifications to the pulses per hour rate can be done through this sub-menu.

See Appendix C.5 for the ENERGY programming screens.

Adjust pulses (W or VAR) allows the selection of a DIVISOR from the list below. *(CAUTION: Changing the divisor and confirming the selections will reset ALL energy readings.)*

Divisor
1000
100
10
1
0.1
0.01
0.001

The reset option resets ALL energy readings.

When entering data, numbers can be entered into the unit in the following way:

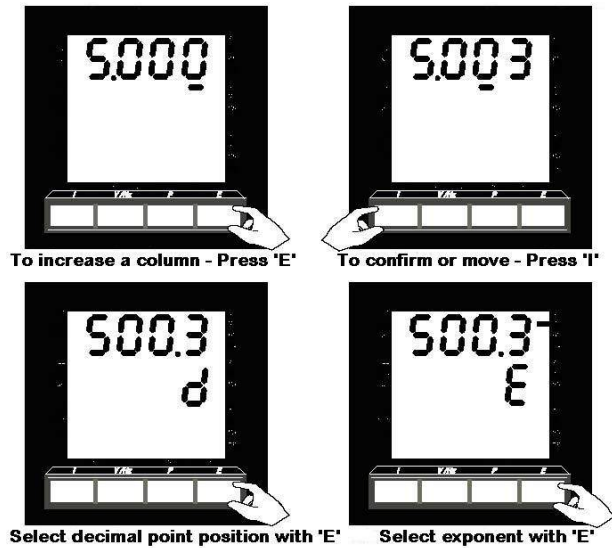

When only fixed data can be entered, you can select the values from the list:

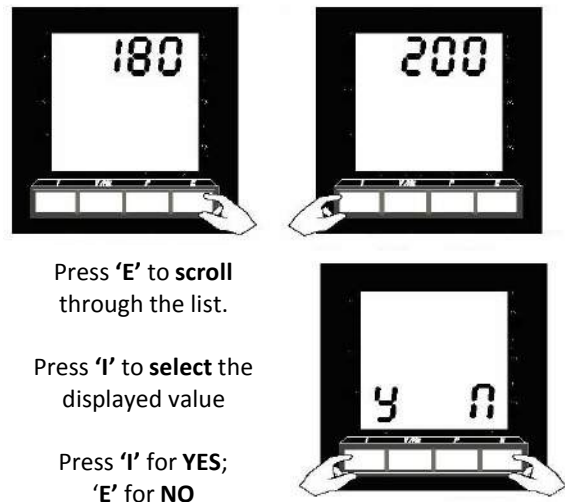

**5.2.5
Relay (RLAY) Sub-Menu**

This sub-menu contains screens for: Relay Type; Pulse Length; Pulses per Hour; Canceling and Confirming actions within this section.

The Pulsed Output option of the M850-LTHN-RS-PO can operate as W.h. or VAR.h. types. The principal relay can be set up in this sub-menu. If you require two pulse output, than you need to purchase M850-LCD with two pulse output module.

The pulse length of the relay(s) can be set from the list below (0-200 ms). Pulses per Hour (PPH) are modified using the decimal point positioning method.

Pulse Length (in milliseconds)
OFF
40
60
80
100
120
140
160
180
200

When entering data, numbers can be entered into the unit in the following way:

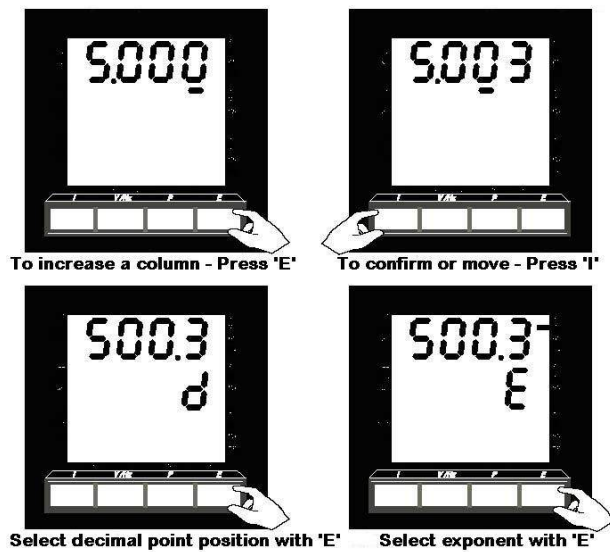

When only fixed data can be entered, you can select the values from the list:

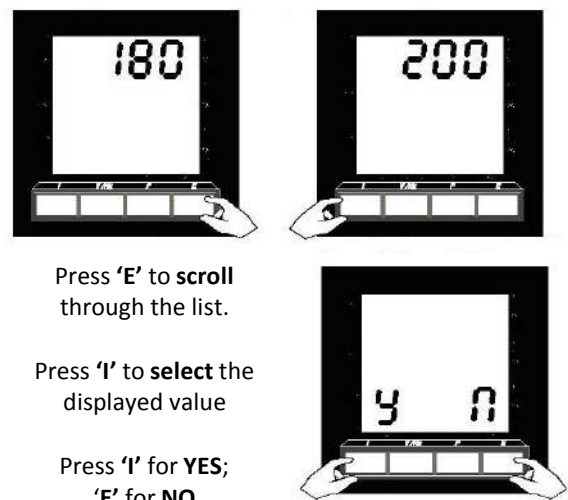

See Appendix C.6 for the RELAY programming screens.

5.2.6

Code (CODE) Sub-Menu

This sub-menu contains screens for: Edit; Set; Canceling and Confirming actions within this section. See Appendix C.6 for the CODE programming screens.

Within this sub-menu, password protection can be set to prevent accidental and unauthorized tampering of the M850-LTHN's settings. The Pass Code can be changed using the EDIT facility in the sub-menu. It is activated using the SET option. If passcode is set and forgotten, the meter will need to be returned to factory for resetting.

5.2.7

EEPROM (STOR) Sub-Menu

This sub-menu contains screens for: Canceling and confirming any actions to be saved to the unit's non-volatile memory. See Appendix C.8 for the STORE programming screens.

It is recommended that whenever settings have been updated that this option be used. However, the unit will save all settings on a power down or brown-out condition.

5.2.8

END (END) Sub-Menu

This selection exits the main menu and resumes displaying measurements on the M850-LTHN. See Appendix C.9 for the END programming screens.

Chapter 6: Configuring the M850-LTHN Using the Front Panel

6.1

System Type Programming

1. Press “I” & “E” simultaneously and hold for 5 seconds. The unit is now in setup mode. The screen will change to “SUPP”. (Most times, the display goes through “SUPP” directly to “SYSA”. This is due to a timing problem with releasing the buttons.)
2. Press “I” button once. The screen displays “SYSA”.
3. Press “E” button until “TYPE” is displayed.
4. Press “I” to select the desired phase/wire configuration.
5. Press “E” to change to the desired phase/wire configuration.
6. Press “E” to choose: 1P3, 1P2, 3P3, 3P4, 3P3b, or 3P4b. Press “I” to set. The screen returns to “Type”.
7. Press “E” until “CONF” is displayed. Then, press “I”. Now the display shows “SUPP”.
8. Press “E” until “END” is displayed. Then, press “I”. Now you are out of programming mode.
9. Check the resulting display on the meter for voltage and current to see that the desired numeral is displayed and the decimal is in the proper location.
10. If not, repeat procedure starting with step 1 and check that the proper numbers are programmed into the meter.

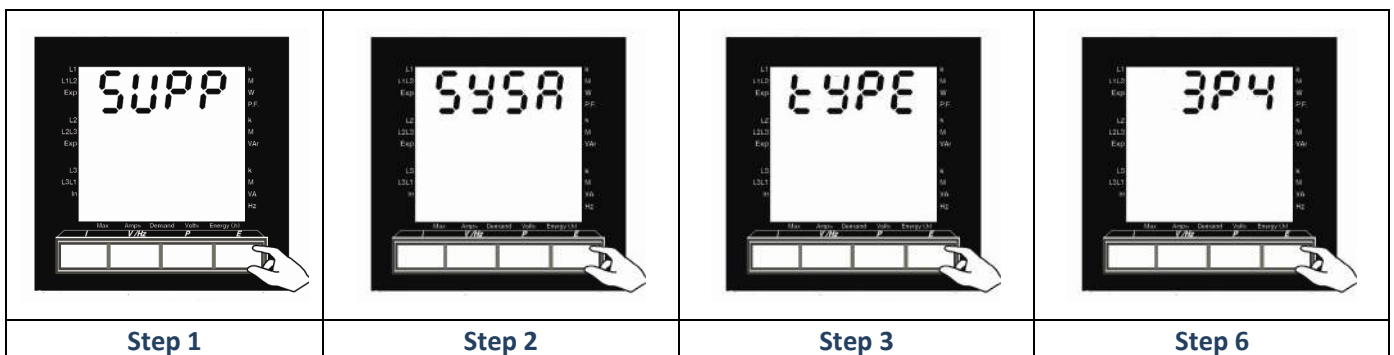

6.2

Configure CT Setting

Internally the M850-LTHN MultiPower is fitted to with either 5 Amp (as standard), 1 Amp and 0.333mV are optional. The current circuit is designed for connection to the secondary of external CT. These transformers should conform to at least Class 1 as per BS7626 (IEC 185) or equivalent. The secondary of these external transformers must have the same nominal current input as that specified on the data label on the M850-LTHN. For example, if the M850-LTHN has a current ratio specified as 500/5A, then the CT could be changed to 800/5A (or any ratio with secondary 5A), once the current ratio has been programmed into the M850-LTHN it is ready to us.

But if the ratio change was 800/1A, the M850-LTHN would have to be returned to the factory to have the internal circuits changed to 1 Amp at a cost.



Warning: The secondary of a current transformer must never be allowed to be in an open circuit condition when the primary is energized. In the open circuit condition high voltage may be present. Each current transformer secondary should be short-circuited when not connected to the meter.

6.2.1

CT Ratio Programming

1. Press “I” & “E” simultaneously and hold for 5 seconds. The unit is now in setup mode. The screen will change to “SUPP”
2. Press “I” button once. The screen displays “SYSA”.
3. Press “I” button once. The screen displays the Primary Ampere setting.
4. Press “I” to select the desired numeral to be changed. i.e.: for a CT primary of 2000Amps, the display will show 2.000KA.
5. Press “E” to change to the desired digit. i.e.: for a CT primary of 2000Amps, the display will show 2.000KA. Press “I” to set.
6. When the screen displays “d” you can select a decimal location by pressing “E”. Press “I” to set.
7. The screen then will display “E” for descriptor selection. Press button “E” to select K (kilo)/ M (mega) or no descriptor.
8. Press “I” once. The display will read “SYSA”.
9. Press “E” until “CONF” is displayed. Then press “I”. Now the display shows “SUPP”.

10. Press “E” until “END” is displayed. Then press “I”. Now you are out of programming mode.
11. Check the resulting display on the meter for voltage and current to see that the desired numeral is displayed and the decimal is in the proper location.
12. If not, repeat procedure starting with step 1 and check that the proper numbers are programmed into the meter.

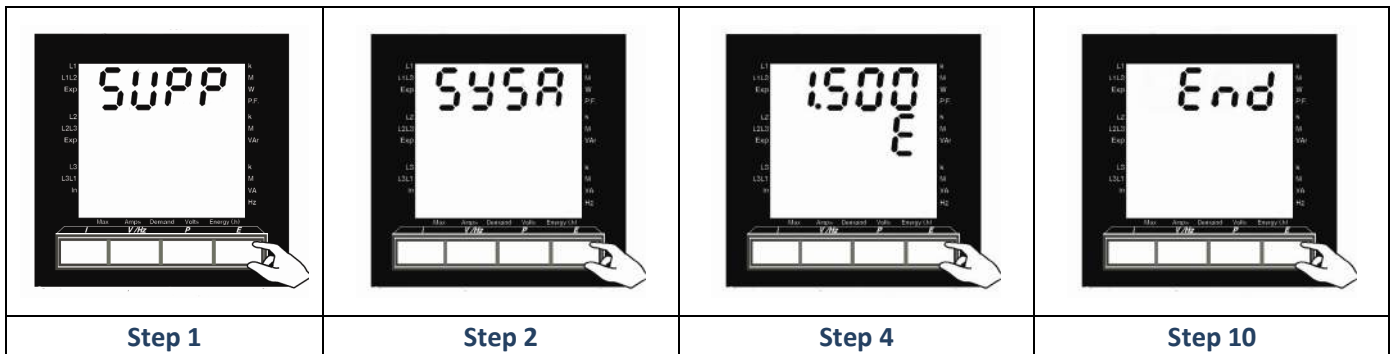

6.3

Configure VT (or PT) Ratio Setting







Connection of voltages higher than the rated voltage that is specified on the M850-LTHN data label, is possible using external voltage transformers. These transformers must be at least Class 1 accuracy.

6.3.1

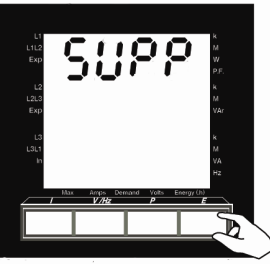
VT (or PT) Ratio Programming

1. Press "I" & "E" simultaneously and hold for 5 seconds. The unit is now in setup mode. The screen will change to "SUPP"
2. Press "I" button once. The screen displays "SYSA".
3. Press "E" button once. The screen displays "UPr1".
4. Press "I" once. The screen displays the VT Primary Voltage setting.
5. Press "I" to select the desired digit. i.e.: for a VT Primary of 280Volts, the display will show 280.0.
6. Press "E" to change to the desired digit. i.e.: for a VT Primary of 400Volts, the display will show 400.0.
Press "I" to set.
7. When the screen displays "d", you can select a decimal location by pressing "E". Press "I" to set.
8. The screen will then display "E" for descriptor selection. Press "E" to select K (kilo) / M (Mega) or no descriptor.
9. Press "I" once. The display will read "UPr1".
10. Press "E" once to display "USEC". Then press "I". Now the display shows the Secondary Voltage setting.
11. Press "I" to select the desired numeral to be changed. i.e.: for a VT secondary of 280Volts, the display will show 280.0.
12. Press "E" to change to the desired digit. i.e.: for a VT secondary of 400Volts, the display will show 400.0.
Press "I" to set.
13. When the screen displays "d", you can select a decimal location by pressing "E". Press "I" to set.
14. The screen will display "E" for descriptor selection. Press "E" to select K(kilo) / M(mega) or no descriptor.
15. Press "I" once. The display will read "USEC".
16. Press "E" until "CONF" is displayed. Then, press "I". Now the display shows "SUPP".
17. Press "E" until "END" is displayed. Then, press "I". Now you are out of programming mode.

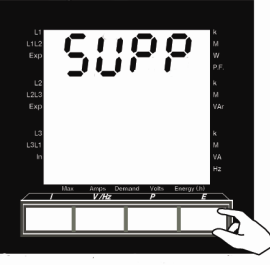
18. Check the resulting display on the meter for voltage and current to see that the desired numbers are displayed and the decimal is in the proper location.
19. If not, repeat procedure starting with step 1 and check that the proper numbers are programmed into the meter.

			
<p style="text-align: center;">Step 1</p>	<p style="text-align: center;">Step 2</p>	<p style="text-align: center;">Step 3</p>	<p style="text-align: center;">Step 10</p>
			
<p style="text-align: center;">Step 16</p>	<p style="text-align: center;">Step 17</p>		

6.4

Configure Max Demand Time Setting

The M850-LTHN integrates all measurements of Amps, Power and VA within a variable time length, sliding window. The reset option will reset all demand and maximum demand measurements. The time demand window can be set to a value of between 3 and 60 minutes (inclusive).

6.4.1

Max Demand Time Setting

In this example, the maximum Demand Time setting will be made to 30 minutes. Here are the programming instructions to set the M850-LTHN to that setting:

1. Press "I" & "E" simultaneously and hold for 5 seconds. The unit is now in setup mode. The screen will change to "SUPP"
2. Press "E" button twice. The screen displays "dt".
3. Press "I" button once. The screen will move into Reset "rSEt" mode.
4. Press "I" to reset any value that may have already been logged. (Press "Y" to reset the value; or, press "N" to keep the value as shown.)
5. Press "E" to show "dtSt" for Demand Time setting.
6. Press "I". This will show what is currently set in minutes. Keep pressing "E" until you get to "0".
7. Press "I" to move to the next digit.
8. Press "E" three times to change the 0 to 3. Now the display should show "30".
9. Press "I" to return to "dtSt".
10. If this is incorrect, press "E" to "CNCL", then "I" and repeat the setting.
11. Press "E" to go the Confirm screen.
12. Press "I" to confirm the setting.
13. Press "E" five times to get to "END."
14. Press "I" to exit the Settings mode of the M850-LTHN

Please note: The M850-LTHN has the capacity to be set up to 60 minutes in 1 minute increments.

If no buttons are pressed for 6 minutes, the M850-LTHN will exit the Settings menu.

Appendix A: MODBUS Registers

A.1

3X and 4X Registers

3X Address	Register	4X Address	Register	Measurement	M550.M560 V4.01	M850-MP 1 Standard	M850-LTHN	M850 dc Version	Order No
30001	(0x0000)	42001	(0x07D0)	VL1-2	Yes	Yes	Yes	***	1
30003	(0x0002)	42003	(0x07D2)	VL2-3	Yes	Yes	Yes	***	2
30005	(0x0004)	42005	(0x07D4)	VL3-1	Yes	Yes	Yes	***	3
30007	(0x0006)	42007	(0x07D6)	V 1	Yes	Yes	Yes	Yes	4
30009	(0x0008)	42009	(0x07D8)	V 2	Yes	Yes	Yes	***	5
30011	(0x000A)	42010	(0x07DA)	V 3	Yes	Yes	Yes	***	6
30013	(0x000C)	42013	(0x07DC)	I 1	Yes	Yes	Yes	Yes	7
30015	(0x000E)	42015	(0x07DE)	I 2	Yes	Yes	Yes	***	8
30017	(0x0010)	42017	(0x07E0)	I 3	Yes	Yes	Yes	***	9
30019	(0x0012)	42019	(0x07E2)	kW Sum	Yes	Yes	Yes	Yes	10
30021	(0x0014)	42021	(0x07E4)	kVA Sum	Yes	Yes	Yes	***	11
30023	(0x0016)	42023	(0x07E6)	kVAR Sum	Yes	Yes	Yes	***	12
30025	(0x0018)	42025	(0x07E8)	PF Avg	Yes	Yes	Yes	***	13
30027	(0x001A)	42027	(0x07EA)	kWhr (Import)	Yes	Yes	Yes	Yes	14
30029	(0x001C)	42029	(0x07EC)	kVAHr (Import)	Yes	Yes	Yes	***	15
30031	(0x001E)	42031	(0x07EE)	Hz	Yes	Yes	Yes	***	16
30033	(0x0020)	42033	(0x07F0)	kW 1	Yes	***	***	***	17
30035	(0x0022)	42035	(0x07F2)	kW 2	Yes	***	***	***	18
30037	(0x0024)	42037	(0x07F4)	kW 3	Yes	***	***	***	19
30039	(0x0026)	42039	(0x07F6)	kVAr 1	Yes	***	***	***	20
30041	(0x0028)	42041	(0x07F8)	kVAr 2	Yes	***	***	***	21
30043	(0x002A)	42043	(0x07FA)	kVAr 3	Yes	***	***	***	22
30045	(0x002C)	42045	(0x07FC)	kWd (Import)	Yes	Yes	Yes	Yes	23
30047	(0x002E)	42047	(0x07FE)	kVAd	Yes	Yes	Yes	***	24
30049	(0x0030)	42049	(0x0800)	Ad	Yes	Yes	Yes	Yes	25
30051	(0x0032)	42051	(0x0802)	Neutral Current	Yes	Yes	Yes	***	26
30053	(0x0034)	42053	(0x0804)	kVA 1	Yes	***	***	***	27
30055	(0x0036)	42055	(0x0806)	kVA 2	Yes	***	***	***	28
30057	(0x0038)	42057	(0x0808)	kVA 3	Yes	***	***	***	29
30059	(0x003A)	42059	(0x080A)	PF L1	Yes	***	***	***	30
30061	(0x003C)	42061	(0x080C)	PF L2	Yes	***	***	***	31
30063	(0x003E)	42063	(0x080E)	PF L3	Yes	***	***	***	32
30065	(0x0040)	42065	(0x0810)	kWhr (Export)	Yes	***	***	Yes	33
30067	(0x0042)	42067	(0x0812)	kVAHr (Export)	Yes	***	***	***	34
30069	(0x0044)	42069	(0x0814)	kVAHr	Yes	***	***	***	35
30071	(0x0046)	42071	(0x0816)	AHr	Yes	***	***	Yes	36
30073	(0x0048)	42073	(0x0818)	kWd (Export)	Yes	***	***	***	37
30075	(0x004A)	42075	(0x081A)	Max kWd (Import)	Yes	Yes	Yes	Yes	38
30077	(0x004C)	42077	(0x081C)	Max kWd (Export)	Yes	***	***	***	39
30079	(0x004E)	42079	(0x081E)	Max kVAd	Yes	Yes	Yes	***	40
30081	(0x0050)	42081	(0x0820)	Max Ad	Yes	Yes	Yes	Yes	41
30083	(0x0052)	42083	(0x0822)	HoursRun	***	* S2	*S2	***	42
30085	(0x0054)	42085	(0x0824)	THD V1	***	* S7	Yes	***	43
30087	(0x0056)	42087	(0x0826)	THD V2	***	* S7	Yes	***	44
30089	(0x0058)	42089	(0x0828)	THD V3	***	* S7	Yes	***	45
30091	(0x005A)	42091	(0x082A)	THD I1	***	* S7	Yes	***	46
30093	(0x005C)	42093	(0x082C)	THD I2	***	* S7	Yes	***	47
30095	(0x005E)	42095	(0x082E)	THD I3	***	* S7	Yes	***	48

*= Special Build

***= Not supported

A.2

Register Addresses and Modes

Modbus Address	Register Address/Name	Mode
40001	(0x00) SYSTEM VOLTAGE	(RO)
40003	(0x02) SYSTEM CURRENT	(R/W)
40005	(0x04) SYSTEM TYPE	(R/W)
40007	(0x06) DEMAND TIME	(R/W)
40009	(0x08) DEMAND STATUS	(RO)
40011	(0x0A) kW.h COUNTER DIVISOR	(R/W)
40013	(0x0C) kVA.h COUNTER DIVISOR	(R/W)
40015	(0x0E) N/A	(N/A)
40017	(0x10) N/A	(N/A)
40019	(0x12) RESET ENERGY	(WO)
40021	(0x14) RESET DEMAND	(WO)
40023	(0x16) N/A	(N/A)
40025	(0x18) N/A	(N/A)
40027	(0x1A) SET NODE ADDRESS	(R/W)
40029	(0x1C) PRIMARY VOLTAGE	(R/W)
40031	(0x1E) SECONDARY VOLTAGE	(R/W)
40097	(0x60) LOCK ACIA SETTINGS	(WO)

Appendix B: M850-LTHN Quick Start Guide

M850 - LED M850 - LCD

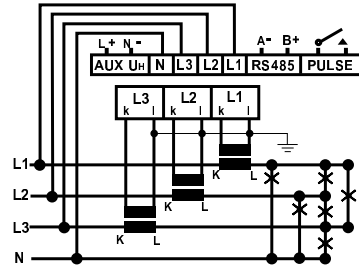

	Voltage			Current			
	L1	L2	L3	N	L1	L2	L3
1ph	✓	✗	✗	✓	✓	✗	✗
1ph 3W	✓	✓	✗	✓	✓	✗	✗
3ph 3W	✓	✓	✓	✗	✗	✗	✗
3ph 4W	✓	✓	✓	✓	✓	✓	✓
3ph 3W BAL	✓	✓	✓	✗	✗	✗	✗
3ph 4W BAL	✓	✗	✗	✓	✓	✗	✗

Unused Voltage terminals are internally connected
Secondary of CTs must be connected to earth

1

2

Display Screens

Each screen is displayed by pressing its appropriate button. (I for Current, V/Hz for Voltage and Frequency, P for Power and E for Energy). Further presses of a screen's button will scroll through the available measurements associated with that button. Each button's state is stored in memory. N.B. the energy readings are permanently displayed on the LCD's fourth line.

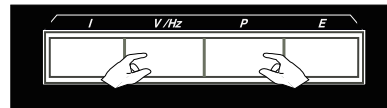

The LED brightness or LCD back-light brightness is adjusted by holding down the two centre buttons. The LCD's back-light colour (blue, white or green) can be changed by holding the 'I' and 'P' buttons down for 6-8 seconds.

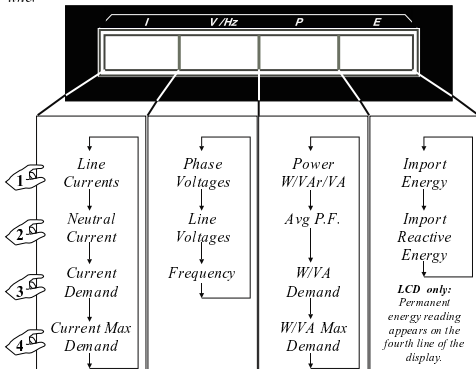

3

Software:
The RS485 option has to be activated or pre-ordered from our local distributor.

Software can be provided for use with the optional RS485 port. The port enables the unit to communicate with devices using the popular Modbus protocol.

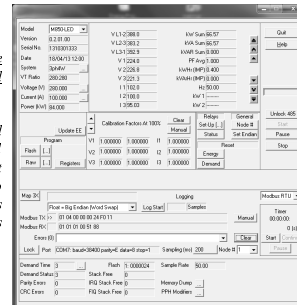

4

Settings Menu

The main menu is entered by holding buttons 'I' and 'E' down for approximately 3 seconds. The main menu and all sub-menus are scrolled through using the 'E' button. Any selection is made using the 'I' button.

If no buttons are pressed for 6 minutes the unit will exit the Settings Menu.

The Settings Menu structure is defined below:

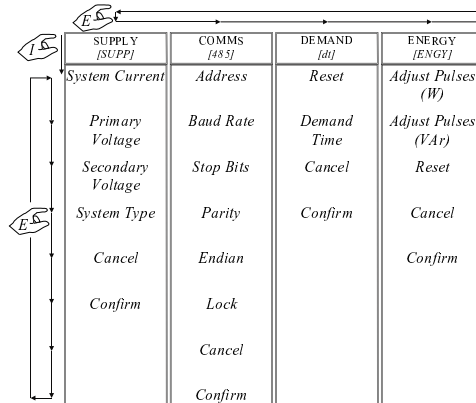

5

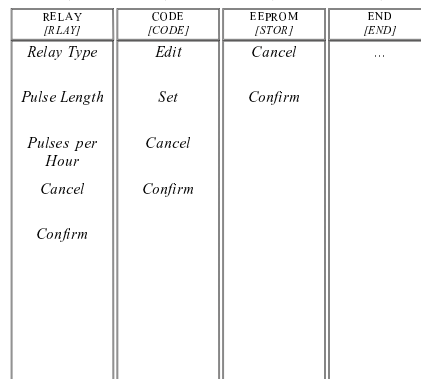

6

Supply [SUPP] The VT ratio and the system current are entered using this sub-menu. The secondary voltage (meter input) is optimised at 280V L-N. Decimal point positioning and exponent selection is used in this section

SYSTEM CURRENT [SYS4]

PRIMARY VOLTAGE [UPRI]

SECONDARY VOLTAGE [USEC]

SYSTEM TYPE [TYPE]

The system's type is selected from the list on the right:

- Un-Balanced
- [1P2] 1 phase 2 wire
- [3P3] 3 phase 3 wire
- [3P4] 3 phase 4 wire
- [1P3] 1 phase 3 wire
- Balanced
- [3P3B] 3 phase 3 wire
- [3P4B] 3 phase 4 wire

Comms [485] (RS485 option is activated or pre-ordered) Network settings can be detected and the unit configured automatically. If manual configuration is preferred, the meter can be set up as follows:

ADDRESS [ADDR] The unit's baud rate, number of stop bits and parity can be selected from the lists on the right:

BAUD RATE [BAUD]

STOP BITS [STOP] Floating point numbers can be transmitted in Big Endian or Little Endian BYTE order and can be selected using the ENDIAN item. (word-swap option selectable for both)

PARITY [PAR]

ENDIAN [ENDI]

LOCK [LOC] Locking prevents the unit hunting for a valid network if communication errors are occurring and can be set using the LOCK item.

- [4.8] 4800 baud
- [9.6] 9600 baud
- [19.2] 19200 baud
- [38.4] 38400 baud
- [57.6] 57600 baud
- [0] no stop bits
- [1] 1 stop bit
- [2] 2 stop bits
- [N] no parity bit
- [O] odd parity bit
- [E] even parity bit

7

Demand [d] The unit integrates all measurements of Amps, Power and VA within a variable time length, sliding window. The reset option will reset all demand and maximum demand measurements.

RESET [RSET]

DEMAND TIME [DTSI] The demand time (window) can be set to a value of between 3 and 60 minutes inclusive.

Energy [ENGY] There are two energy accumulators in the unit; Import Power and Import VAR. Modifications to the pulses per hour rate can be done through this sub-menu.

ADJUST PULSES [ADJ] (W) Adjust pulses (W or VAR) allows the selection of a DIVISOR from the list on the right:

ADJUST PULSES [ADJ] (VAR) Caution: Changing the divisor and confirming the selection will reset ALL energy readings

RESET [RSET] The reset option resets ALL energy readings.

- 1000
- 100
- 10
- 1
- 0.1
- 0.01
- 0.001

Relay [RLAY] The solid-state relay (optional) can operate as a W.h or VAR.h type. The relay's parameters can be set up in this sub-menu.

RELAY TYPE [TYPE]

PULSE LENGTH [PULS LNTH] The pulse length of the relay(s) can be set from the list on the right (0-200ms). PPH are modified using the decimal point positioning method.

PULSES per HOUR [PPH]

- OFF
- 40
- 60
- 80
- 100
- 120
- 140
- 160
- 180
- 200

9

Code [CODE] The Pass Code is used to help prevent unauthorised tampering with the unit's settings.

EDIT PASS CODE [EDIT] The Pass Code can be changed using the EDIT facility in the sub-menu.

SET PASS CODE [SET] It is activated using the SET option.

EEPROM [STOR] The EEPROM sub-menu allows the user to save all settings into the unit's non-volatile memory. It is recommended that this option is used whenever settings have been updated. However, the unit will save all settings on a power down or brown out condition.

END [END] This selection leaves the main menu and resumes displaying measurements.

CANCEL [CNCL] At the end of most sub-menus is the option to cancel any changes made in that sub-menu.

CONFIRM [CONF] Confirmation is required before any changes are implemented. The changes are effective as soon as they are confirmed.

11

Entering Data

When required, numbers can be entered into the unit in the following way:

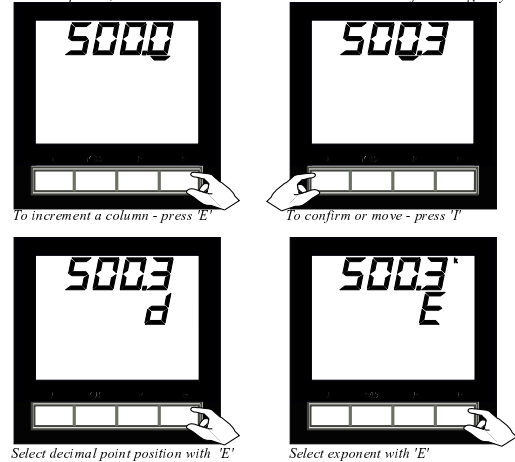

8

Lists

When only fixed data can be entered, selection is made from a list:

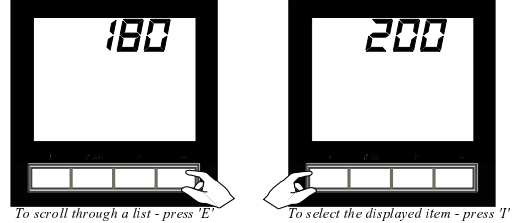

When a decision has to be made the Yes - No screen is displayed

Entering Data - Summary

Pressing the 'T' button accepts the currently selected item and moves on to the next. Pressing the 'E' button either changes the item's option or increments a column. Other menu items that may be displayed are all treated in the same manner.

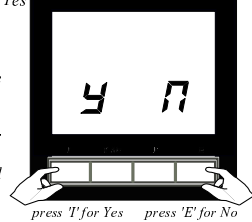

10

Input (accuracy range)
 Un 28V to 330V L-N (48V to 570V L-L)
 Burden < 0.5VA
 In (5A specified) 0.5A to 6A via CT
 In (1A specified) 0.1A to 1.2A via CT
 Burden < 0.5VA
 Frequency 45Hz to 65Hz
 Secondary of CTs must be connected to earth

Input (working range)
 Voltage and Current 1.7% - 100%

Overload
 800V L-L indefinitely, In x 10 for 1 sec

Accuracy (8.4% - 100% of range)
 Voltage 0.5% +/- 2 digits
 Current 0.5% +/- 2 digits
 Power (W, VAR, VA) 1.0% +/- 2 digits
 Power Factor 1% of range
 Frequency 0.1 Hz
 Energy IEC 1036 Class 1

Auxiliary Voltage
 100V to 440V ac (45Hz to 65Hz)
 100V to 420V dc
 Burden: < 10VA

Display
 Digits (LED/LCD) 3 lines 9999
 Digit size 14.2mm 7 segment
 Energy (LCD) 1 line 99999999
 Digit size 6mm 7 segment
 Update time 1 second

Options
 Activated RS485 port (Modbus)
 Solid-state relay (W.h or VAR.h)

Insulation
 Installation Category III (480V ph/ph)
 Degree of Pollution 2
 Rated Impulse Voltage IEC 60947-1-V imp 4kV
 Meter Front Class II
 Electrical Security IEC 61010-1

Electromagnetic Compatibility
 Immunity:
 ESD IEC 61000-4-2-Level III
 Radiated IEC 61000-4-3-Level III
 Fast Transient IEC 61000-4-4-Level III
 Impulse Waves IEC 61000-4-5-Level III
 Conducted IEC 61000-4-6-Level III
 Voltage Dips/ Short Interruptions IEC 61000-4-11-Level III
 Emissions:
 Conducted and Radiated CISPR11-Class A

Environment
 Working Temperature (LED) -10 to 60 deg C
 Working Temperature (LCD) -20 to 70 deg C
 Storage Temperature -30 to 80 deg C
 Relative Humidity 0-95% non condensing
 Shock 30G in 2 planes

Enclosure
 Standard DIN case 96 x 96 x 60mm
 Panel mounting 4 retaining clips
 Cutout 92.8mm x 92.8mm
 IP Rating - Front IP52 / Nema
 IP Rating - Case IP30 / Nema

12

Appendix C: Programming Screens

C.1

Main Menu Screens

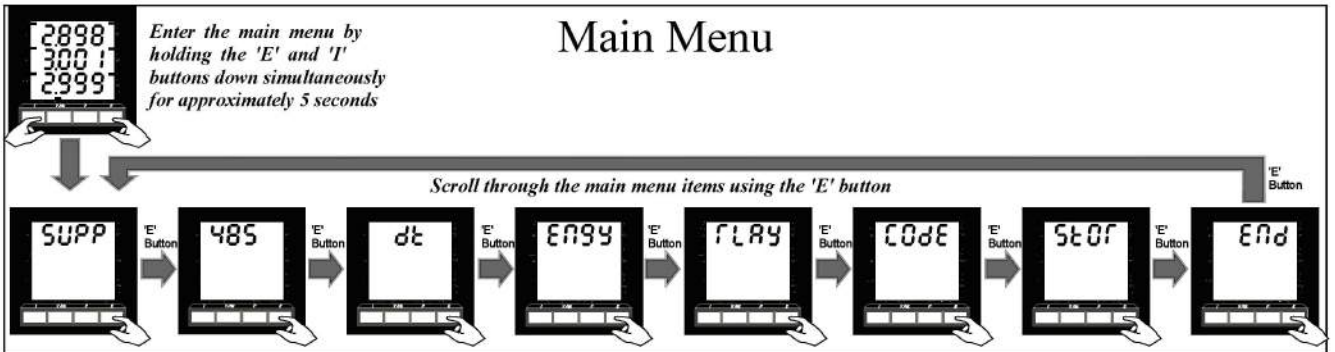

C.2

SUPPLY Programming Screens

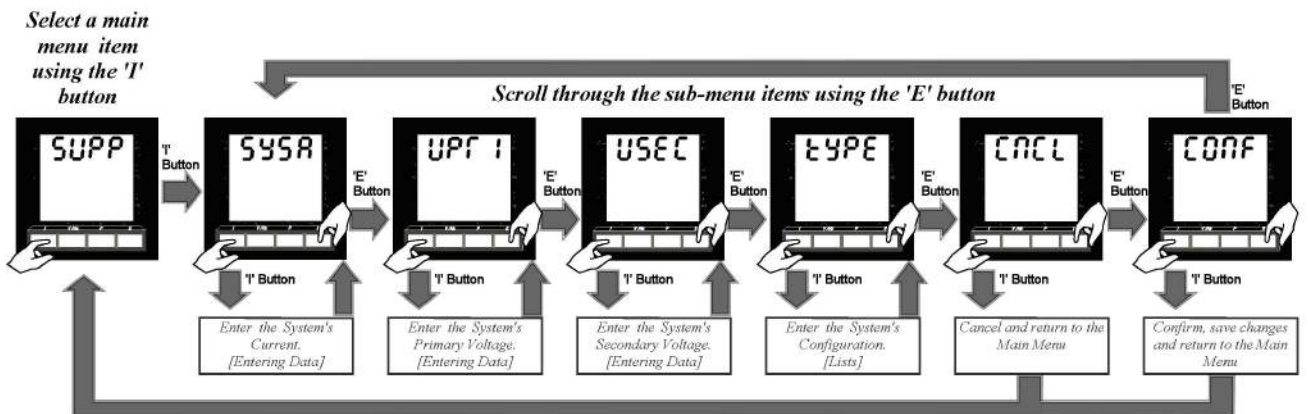

C.3

COMMUNICATIONS Programming Screens

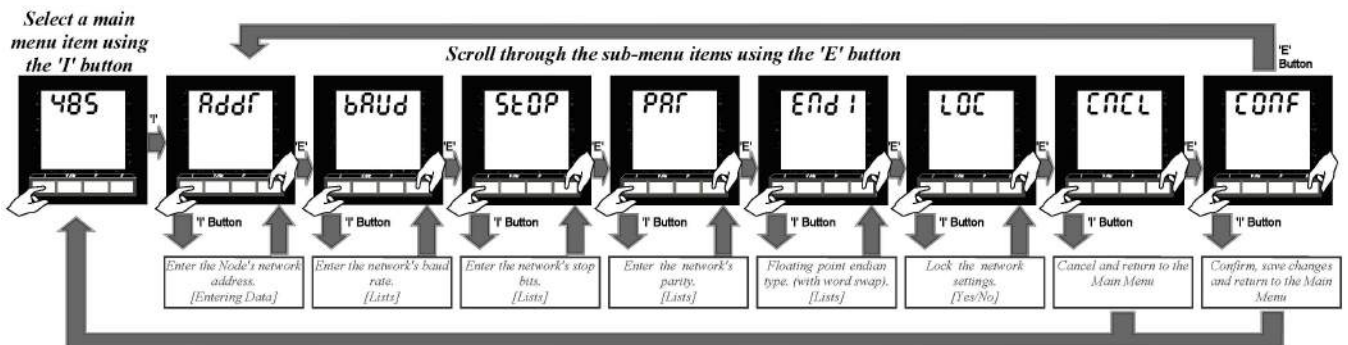

C.4
DEMAND Programming Screens

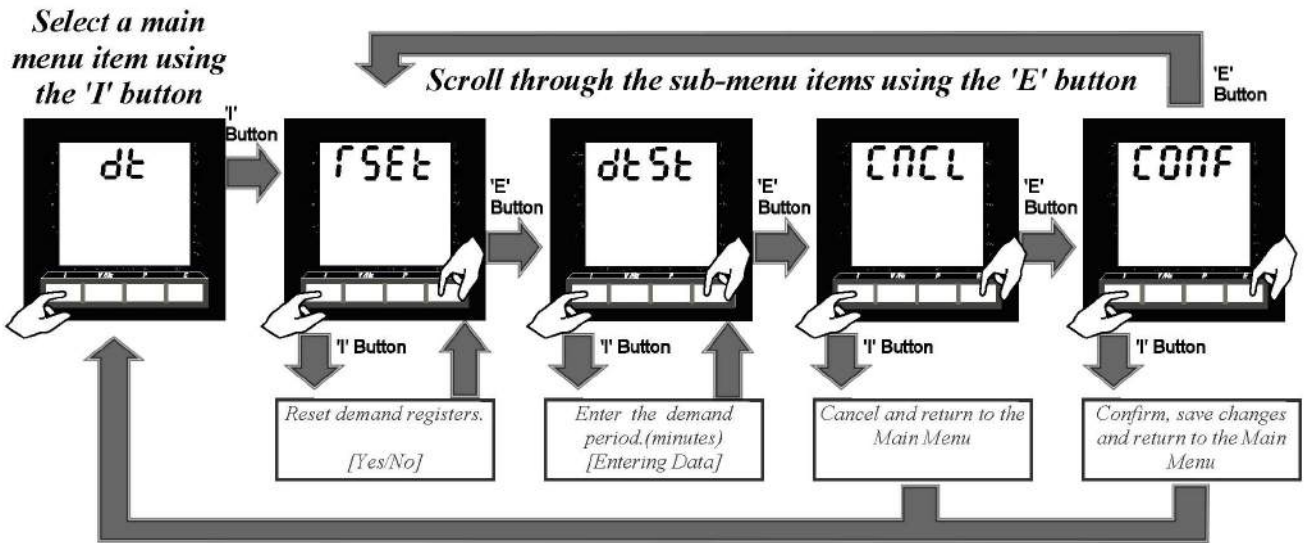

C.5
ENERGY Programming Screens

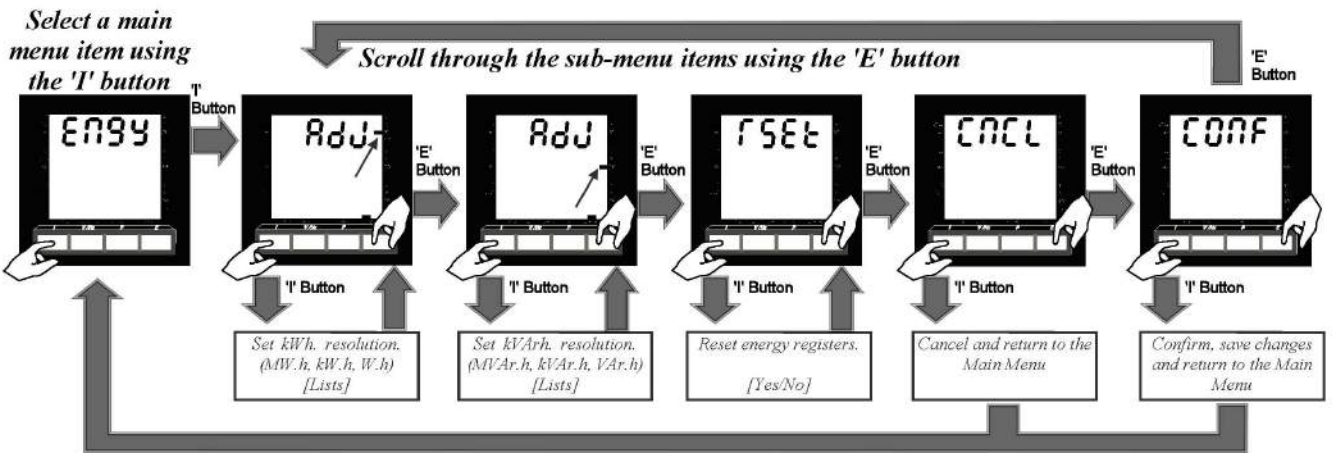

C.6
RELAY Programming Screens

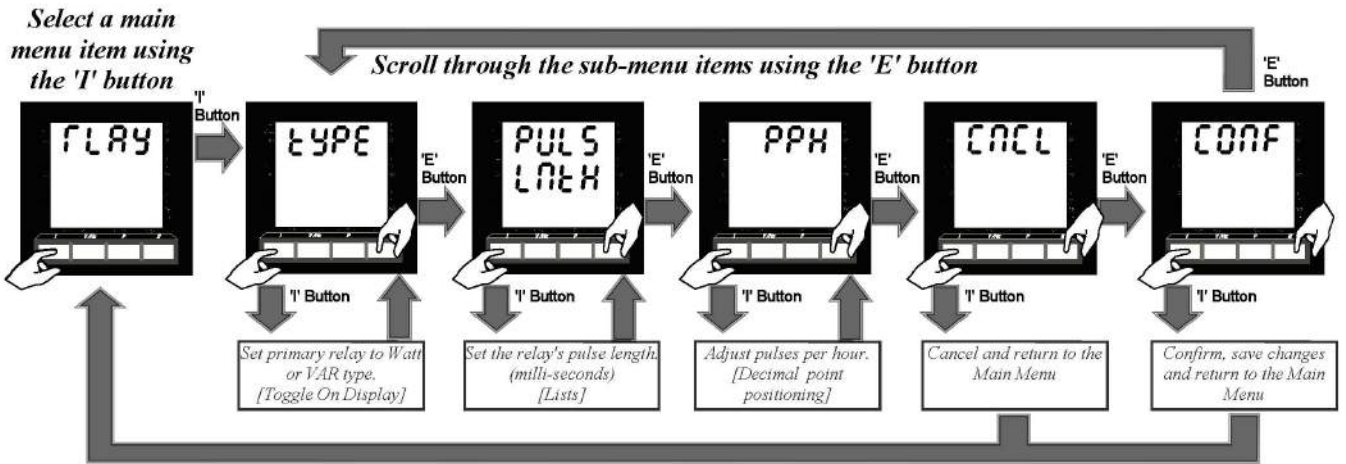

C.7
CODE Programming Screens

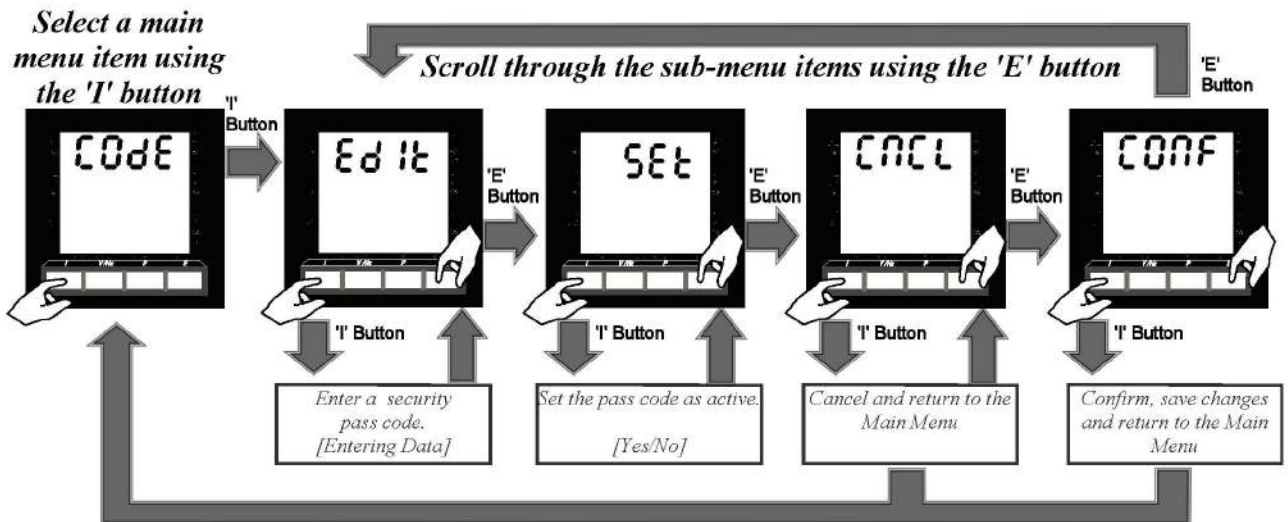

C.8
STORE Programming Screens

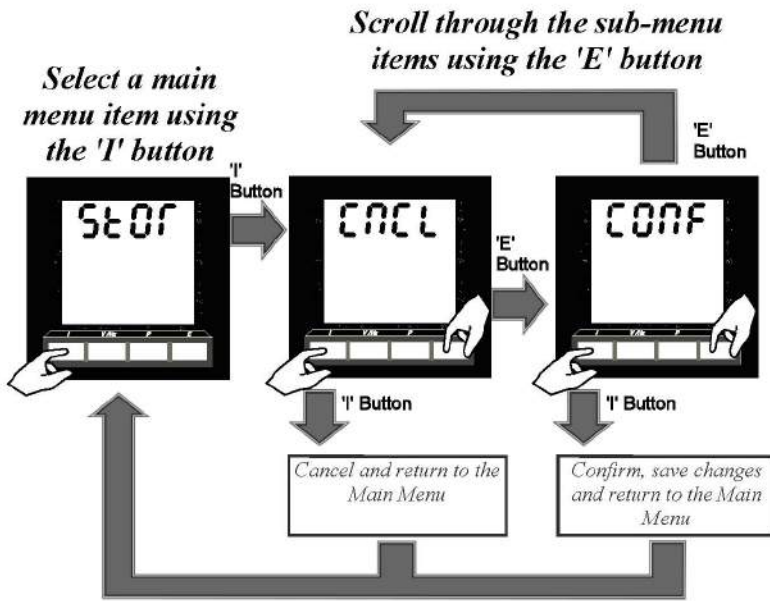

C.9
END Programming Screens

Select a main menu item using the 'I' button

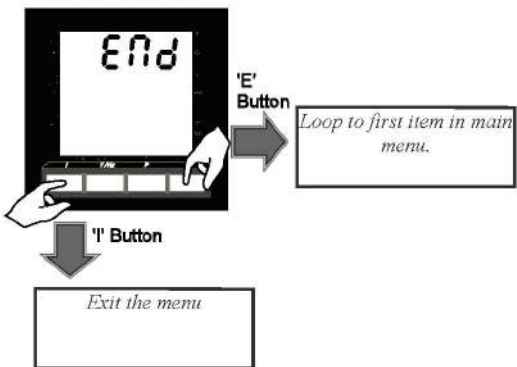

Appendix D: Ethernet Plug-In Card Installation (Model M850-THD-ET) and Set-Up



The Ethernet pod (option) can be installed into either position in the back of a M850 power meter. The pod incorporates a 10/100Base-T Ethernet controller.

The protocols supported are:

1 Telnet	Port 23
2 Modbus TCP/IP	Port 502
3 Modbus TCP	Port 4000
4 HTML	Port 80

A cross-over CAT5 Ethernet cable should be used if the network card doesn't automatically swap lines to suit the cable's terminations.

Configuring the pod

The factory default settings of the pod, IP address 192.168.92.123, mask 255.255.255.0 and default gateway 192.168.92.254, can be recalled by depressing the button under the lid for 15 seconds at any time.

Connect the meter to a computer's network port using a cross-over Ethernet cable.

Set up the computer's port as follows:

Open 'Control Panel'

Windows 7:

Select 'Network and Internet' and then select 'Network and Sharing Center'. Click on Change Adapter Settings.

Windows XP:

Select 'Network and Internet Connections' and then select 'Network Connections'.

- ① Double click the network connection you have connected the pod to.
- ② Select 'Properties'.
- ③ Click on 'Internet Protocol 4' or 'Internet Protocol (TCP/IP)' and 'Properties'.
- ④ Using the example, enter the recommended settings. (IP = 192.168.92.68, Subnet = 255.255.255.0, Gateway = 192.168.92.254)

The pod will now be accessible through a web browser using the network address 192.168.92.123. To change any settings in the pod and/or meter at this stage will require the use of a Telnet client program. Computers using a Windows operating system have this ready to be installed.

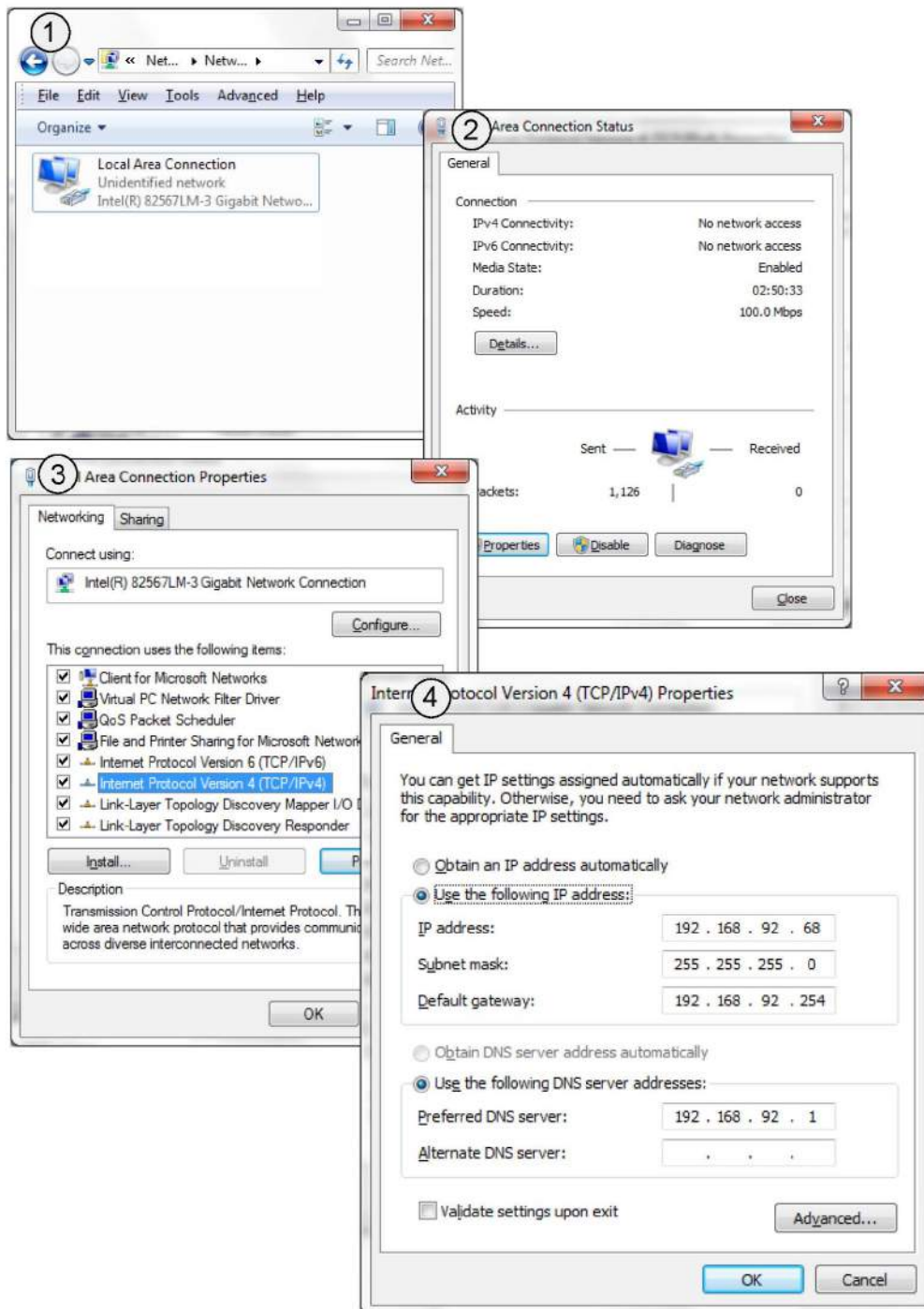

Installing Telnet (client) Software

Windows 7:

Open 'Control Panel' and click on 'Programs'
Select 'Turn Windows Features on or off'.

①

From the list shown, tick the Telnet Client box and then OK.

The software will be installed and access to it will be through the RUN command from Windows 'Start->All Programs ->Accessories'

②

Enter telnet to run the program.

Windows XP:

From the Start menu, select RUN.

②

In the Open drop-down list box, type in Telnet to run the program.

At the prompt type in:
O 192.168.92.123

③

A menu will be displayed.

It's here that final network settings can be entered and meter settings changed.

e.g. To change the network address to 192.168.92.21, enter
5 192.168.92.21

Note. IP address, mask and gateway changes are not implemented until Telnet is closed using command q.

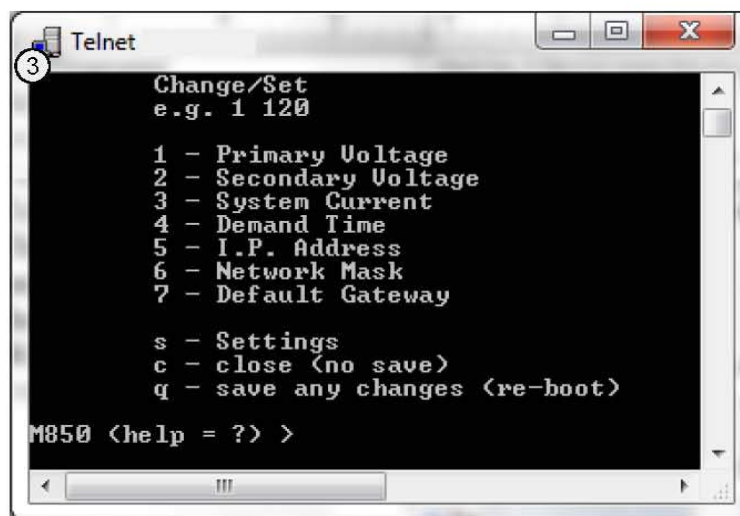
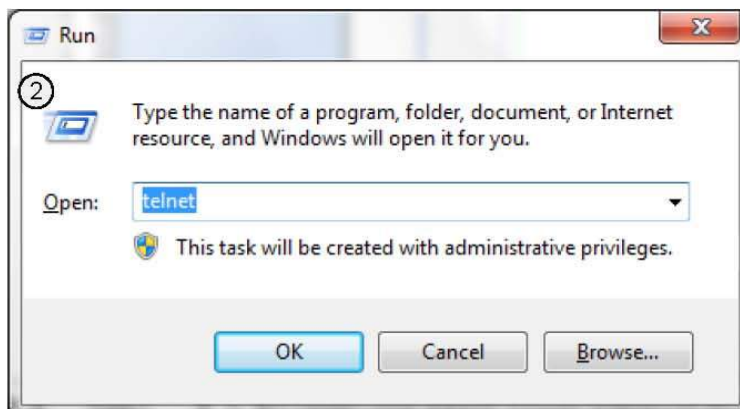
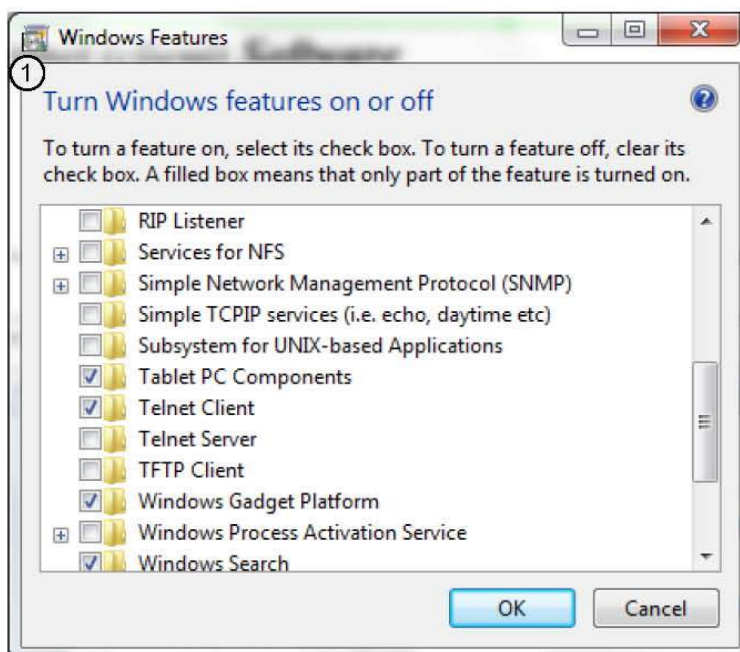

Connecting to an existing network:

The network settings will have to be obtained from the network administrator.

If the network settings match those of the pod's and its address is unique to that network, the pod can be introduced onto the network and used without alteration.

Alternatively, new network settings will have to be entered using Telnet as previously documented.

SCADA software using Port 502 can use the Modbus TCP/IP protocol to monitor the meter.

Mult View software (Windows application) using Port 4000 and a virtual port driver (not supplied) can be used to monitor the meter.

A browser (HTTP Port 80), using the meter's IP address (default 192.168.92.123), will show the front page of the controller with the option of displaying measurements from the meter and also verify the meter's connection.

MultiPower (M850) System Measurements	Meter Data	
	Model	850
	Serial Number	1105191402
	Firmware version	2.010
	System Voltage	280.0
	System Current	5.000
	LAN (static IP)	
	IP Address	192.168.92.123
	Network Mask	255.255.255.0
	Default Gateway	192.168.92.254
MAC Address	0.4.163.80.60.142	
Use a Telnet application to change settings (available on request)		

MultiPower (M850) System Measurements	VL1L2:	398.5	kWsum:	503.4
	VL2L3:	398.0	kVAsum:	547.2
	VL3L1:	398.7	kVArsum:	204.9
	V1N:	230.1	PFavg:	0.920
	V2N:	229.8	kWh:	3427
	V3N:	230.2	kVArh:	296
	I1:	801.5	Hz:	60.05
	I2:	780.6	kWd:	435.6
	I3:	796.8	kVAd:	503.2
	NI:	23.4	Ad:	758.4
	kWdMax:	387.3	kVAdMax:	684.5
	AdMax:	768.9		

Notes: